

HP 8660D SYNTHESIZED SIGNAL GENERATOR

(Including Options 001, 002, 003, and 005)

Operation and Calibration Manual

SERIAL NUMBERS

This manual applies directly to instruments with serial numbers prefixed:

3006A and all *MAJOR* changes that apply to your instrument.

This material may be reproduced by or for the U.S. Government pursuant to the Copyright License under the clause at DFARS 52.227-7013 (APR 1988).

Copyright © HEWLETT-PACKARD COMPANY 1987
P.O. BOX 2500, SPOKANE, WASHINGTON, U.S.A. 99220-2500

Valuetronics International, Inc.

1-800-552-8258

MASTER COPY

Operation and Calibration Manual HP Part 08660-90103

Other Documents Available:

Service Manual (Volume 2, 3) HP Part 08660-90104

Microfiche Operation and Calibration Manual HP Part 08660-90105

Microfiche Service Manual HP Part 08660-90106

Printed in U.S.A. : March 1993



CERTIFICATION

Hewlett-Packard Company certifies that this product met its published specifications at the time of shipment from the factory. Hewlett-Packard further certifies that its calibration measurements are traceable to the United States National Bureau of Standards, to the extent allowed by the Bureau's calibration facility, and to the calibration facilities of other International Standards Organization members.

WARRANTY

This Hewlett-Packard instrument product is warranted against defects in material and workmanship for a period of one year from date of shipment. During the warranty period, Hewlett-Packard Company will at its option, either repair or replace products which prove to be defective.

For warranty service or repair, this product must be returned to a service facility designated by HP. Buyer shall prepay shipping charges to HP and HP shall pay shipping charges to return the product to Buyer. However, Buyer shall pay all shipping charges, duties, and taxes for products returned to HP from another country.

HP warrants that its software and firmware designated by HP for use with an instrument will execute its programming instructions when properly installed on that instrument. HP does not warrant that the operation of the instrument, or software, or firmware will be uninterrupted or error free.

LIMITATION OF WARRANTY

The foregoing warranty shall not apply to defects resulting from improper or inadequate maintenance by Buyer, Buyer-supplied software or interfacing, unauthorized modification or misuse, operation outside of the environmental specifications for the product, or improper site preparation or maintenance.

NO OTHER WARRANTY IS EXPRESSED OR IMPLIED. HP SPECIFICALLY DISCLAIMS THE IMPLIED WARRANTIES OF MERCHANTABILITY AND FITNESS FOR A PARTICULAR PURPOSE.

EXCLUSIVE REMEDIES

THE REMEDIES PROVIDED HEREIN ARE BUYERS'S SOLE AND EXCLUSIVE REMEDIES. HP SHALL NOT BE LIABLE FOR ANY DIRECT, INDIRECT, SPECIAL, INCIDENTAL, OR CONSEQUENTIAL DAMAGES, WHETHER BASED ON CONTRACT, TORT, OR ANY OTHER LEGAL THEORY.

ASSISTANCE

Product maintenance agreements and other customer assistance agreements are available for Hewlett-Packard products.

For any assistance, contact your nearest Hewlett-Packard Sales and Service Office. Addresses are provided at the back of this manual.

SAFETY CONSIDERATIONS

GENERAL

This product and related documentation must be reviewed for familiarization with safety markings and instructions before operation.

This product is a Safety Class I instrument (provided with a protective earth terminal).

BEFORE APPLYING POWER

Verify that the product is set to match the available line voltage and the correct fuse is installed.

SAFETY EARTH GROUND

An uninterruptible safety earth ground must be provided from the main power source to the product input wiring terminals, power cord, or supplied power cord set.

SAFETY SYMBOLS



Instruction manual symbol: the product will be marked with this symbol when it is necessary for the user to refer to the instruction manual (refer to Table of Contents).



Indicates hazardous voltages.



Indicates earth (ground) terminal.

WARNING

The WARNING sign denotes a hazard. It calls attention to a procedure, practice, or the like, which, if not correctly performed or adhered to, could result in personal injury. Do not proceed beyond a WARNING sign until the indicated conditions are fully understood and met.

CAUTION

The CAUTION sign denotes a hazard. It calls attention to an operating procedure, practice, or the like, which, if not correctly performed or adhered to, could result in damage to or destruction of part or all of the product. Do not proceed beyond a CAUTION sign until the indicated conditions are fully understood and met.

WARNING

Any interruption of the protective (grounding) conductor (inside or outside the instrument) or disconnecting the protective earth terminal will cause a potential shock hazard that could result in personal injury. (Grounding one conductor of a two conductor outlet is not sufficient protection).

Whenever it is likely that the protection has been impaired, the instrument must be made inoperative and be secured against any unintended operation.

If this instrument is to be energized via an autotransformer (for voltage reduction) make sure the common terminal is connected to the earth terminal of the power source.

Servicing instructions are for use by service-trained personnel only. To avoid dangerous electric shock, do not perform any servicing unless qualified to do so.

Adjustments described in the manual are performed with power supplied to the instrument while protective covers are removed. Energy available at many points may, if contacted, result in personal injury.

Capacitors inside the instrument may still be charged even if the instrument has been disconnected from its source of supply.

For continued protection against fire hazard, replace the line fuse(s) only with 250V fuse(s) of the same current rating and type (for example, normal blow, time delay, etc.). Do not use repaired fuses or short circuited fuseholders.

VOLUME 1 CONTENTS

Section 1 - General Information

Description	1-1
Introduction to the Operation and Calibration Manual	1-1
Volume I, Operation and Calibration Manual	1-1
Where to Find Instrument Specifications	1-1
Where to Find Safety Considerations	1-2
Hewlett-Packard Interface Bus (HP-IB) Enables Remote Control	1-2
Selecting the HP-IB Address	1-2
Accessories Supplied with the HP 8660D	1-2
Equipment Required but Not Supplied	1-2
Options Available with the Instrument	1-3
Electrical Options	1-3
Mechanical Options	1-3
Manual Options	1-3
General Operating Principles	1-3
Equipment Available	1-3
How to Use the Recommended Test Equipment Table	1-6

Section 2 - Installation

Introduction to This Section	2-1
Initial Inspection	2-1
Preparation for Use	2-1
Power Requirements	2-1
Line Voltage Selection	2-1
Power Cable	2-2
Operating Environment	2-3
Remote Selection	2-3
Rack Mounting (Option 908)	2-4
Storage and Shipment	2-4
Environment	2-4
Packaging	2-6

Section 3 - Operation

Introduction to This Section	3-1
Panel Features	3-1
Operator's Maintenance	3-4
Operating Principles	3-4
Local Operation	3-4
Sweep Functions	3-4
Manual Tuning	3-5
Operator's Checks	3-5
Initial Turn-On Check	3-5
Keyboard Register and Readout Checks	3-6
Step \uparrow \downarrow and RANGE Annunciator Check Using the HP 86601 RF Section.	3-6

Section 3 – Operation (cont'd)

Operator's Checks (cont'd)

- STEP ↑ ↓ Register and RANGE Annunciator Check with the HP 86602A RF Section. 3-7
- STEP ↑ ↓ Register and RANGE Annunciator Check with the HP 86603A RF Section. 3-8
- Manual Mode - Manual Tuning Check (With 86601A) 3-8
- Sweep Mode Checks with 86601A RF Section 3-9
- Sweep Mode Checks with 86602A, 86602B or 86603A RF Sections 3-9
- Manual Sweep Check 3-10
- Single Sweep Check 3-10
- Modulation Plug-ins 3-10
- Error Codes 3-10
- HP-IB Programming; "OLD" and "NEW" Codes Explained 3-10
- Signal Generator Function to "NEW" HP-IB Codes 3-12
- HP-IB Capabilities 3-13
- Example Program 3-14
 - HP-IB Address Selection 3-16
 - Further HP-IB Programming Information 3-16
- BCD Remote Operation 3-17
 - Data Inputs 3-20
 - Flag Signal 3-20
 - Reset 3-20

Section 4 – Performance Tests

- Introduction 4-1
- Equipment Required 4-1
- Test Record 4-1
- Performance Test 1 — Internal Crystal Oscillator Aging Rate 4-
- Performance Test 2 — Reference Test 4-4
- Performance Test 3 — Phase Locked Loops Test 4-5

Section 5 – Adjustments

- Introduction 5-1
- Periodic Adjustments Required 5-1
- Equipment Required 5-1
- Adjustment Aids 5-1
- Factory Selected Components 5-2
- Related Adjustments 5-2
- Adjustment Locations 5-2
- Checks and Adjustments 5-2
- Safety Considerations 5-2
- Adjustment 1 — Phase Locked Loops (Abbreviated) 5-5
- Adjustment 2 — Power Supply 5-9
- Adjustment 3 — Reference Section 5-11
- Adjustment 4 — 10 MHz Bandwidth Filter (After Repair) 5-16
- Adjustment 5 — 10 MHz Bandpass Filter 5-18
- Adjustment 6 — High Frequency Section 5-19
- Adjustment 7 — N1 Phase Lock Loop 5-25
- Adjustment 8 — N2 Phase Lock Loop 5-27
- Adjustment 9 — N3 Phase Lock Loop 5-29
- Adjustment 10 — Summing Loop 2 (SL2) 5-31
- Adjustment 11 — Summing Loop 1 (SL1) 5-31
- Adjustment 12 — DCU Sweep Output 5-31

Section 1 GENERAL INFORMATION

1-1. DESCRIPTION

The HP 8660D Synthesized Signal Generator mainframe, pictured in Figure 1-1, requires two plug-in sections to provide a useable RF output. The plug-ins required are an RF Section and a Modulation (or Auxiliary) Section. These plug-in sections are inserted into the front of the HP 8660D; all operating controls are on the front panels of the plug-in sections or on the mainframe panel.

An internal plug-in unit, the Frequency Extension Module (HP 11661A) is required when any RF Section other than the HP Model 86601 is in use.

The HP 8660D is programmable using either HP-IB (Hewlett-Packard Interface Bus) or BCD (Binary Coded Decimal).

1-2. INTRODUCTION TO THE OPERATION AND CALIBRATION MANUAL

This manual contains information required for a qualified person to install, operate, test, adjust, and service the Hewlett-Packard Model 8660D Synthesized Signal Generator mainframe. The HP 8660D will generally be referred to as the Signal Generator throughout the manual.

The Operation and Calibration Manual is comprised of five sections as described below:

Volume I, Operation and Calibration Manual

Section I, General Information. General Information covers instrument specifications, options, equipment available, and recommended test equipment.

Section II, Installation. Installation covers initial inspection, preparation for use, and storage and shipment.

Section III, Operation. Operation provides HP-IB operating information and detailed operating information for either the beginning or experienced user.

Section IV, Performance Tests. Performance tests enable you to check the performance of the instrument against the specifications listed in Table 1-1.

Section V, Adjustments. Adjustment procedures provide information required to adjust and align the instrument after repairs are made.

1-3. WHERE TO FIND INSTRUMENT SPECIFICATIONS

Instrument specifications are listed in Table 1-1. These specifications are the performance standards or limits against which the instrument can be tested.

1-4. WHERE TO FIND SAFETY CONSIDERATIONS

This product is a Safety Class I instrument; that is, one provided with a protective earth terminal. Before operating or servicing the Signal Generator, service personnel should familiarize themselves with the safety markings on the Signal Generator and the safety instructions in the manual. Safety information regarding installation, operation, performance testing, or adjusting of the HP 8660D is found throughout this manual. Refer to the Safety Considerations pages found at the beginning of this manual for a summary of that information.

1-5. HEWLETT-PACKARD INTERFACE BUS (HP-IB) ENABLES REMOTE CONTROL

The Signal Generator has a Hewlett-Packard Interface Bus (HP-IB) interface and can be used with an HP-IB compatible controller for test system applications. The Signal Generator is fully programmable via the Hewlett-Packard Interface Bus. Operation of the plug-in sections may also be remotely programmed through the mainframe circuits. Both BCD (Binary Coded Decimal) and HP-IB are available for use in programming the Signal Generator. An extended set of programming codes is used in the HP 8660D, although the codes found with the HP 8660A/C manual are completely compatible with the HP 8660D. HP-IB is Hewlett-Packard's implementation of IEEE Standard 488 and the identical ANSI Standard MC1.1.

(Refer to Section III for more complete details about programming the HP 8660D.)

Selecting the HP-IB Address

The Signal Generator's HP-IB address is set to 19 at the factory in both internal memory. Refer to Remote Selection in Section 2 for information regarding changing the HP-IB address.

1-6. ACCESSORIES SUPPLIED WITH THE 8660D

- A detachable three-wire power cable. The type of power cord will be determined by the shipment destination. For the part numbers of the power cables, refer to Table 2-1, AC Power Cables Available. Signal Generators shipped to countries using 115 volts are also supplied with a set of fuses for 230 volt operation.
- An accessory kit (08660-60417) consisting of the following:

1	Connector, Type-N-to-BNC	1250-0780
1	Extender Board 20 contact	5060-0256
1	Extender Board 24 contact	5060-0258
2	Extender Boards 30 contact	5060-0276
1	Connector 36 pin with hood and clamp	1251-0084
2	Extenders	08660-60406
1	Extender	08660-90102

- A BCD to HP-IB Adapter HP Part Number 08660-60187 (attached to rear panel).

1-7. EQUIPMENT REQUIRED BUT NOT SUPPLIED

An RF Section and Modulation or Auxiliary Section must be installed in the HP 8660D mainframe. In addition, when an RF section such as the HP 86602 or HP 86603 is used, the internal Frequency Extension Module (HP 11661) must be used.

1-8. OPTIONS AVAILABLE WITH THE INSTRUMENT

Electrical Options

Option 001: $\pm 3 \times 10^{-9}$ /24 hours internal oscillator (Standard).

Option 003: Operation from 48 to 440 Hz line (Standard).

Option 005: Factory configured for HP-IB Operation.

NOTE

To connect an HP-IB cable to the rear panel requires an adapter HP Part Number 08660-60187. This adapter is shipped with instruments ordered with Option 005.

Option 100: HP 11661B factory installed.

Option W30: Extends hardware support three years.

Mechanical Options

Option 908: Adds a rack-mount kit. If the HP 8660D was purchased without the rack-mount option, the kit may be ordered from the nearest Hewlett-Packard office using HP part number 08660-60347.

Manual Options

Option 910: Adds Extra Manual Set (1 additional Operation/Calibration Manual plus 2 Service Manuals).

Option 915: Adds Service Manual (1 copy).

1-9. GENERAL OPERATING PRINCIPLES

All of the signals generated in the HP 8660D are phase locked, directly or indirectly, to a 100 MHz master oscillator in the reference section. The 100 MHz master oscillator is phase locked to an internal temperature controlled oscillator or to an external standard. Provisions are made for the internal oscillator to be used as a reference signal for other equipment.

The HP 8660D uses synthesizer techniques to provide digitally controlled, precise RF signals which are used in the RF Section output plug-ins to produce the selected output frequency. The output frequencies are exactly those selected in 1 Hz or 2 Hz increments.

Six phase-locked loops, all phase locked to the 100 MHz master oscillator, are used to generate the RF signals used in the RF Section plug-ins to produce the final output signal.

The HP 8660D functions can be selected by front-panel controls or by a remote controller. RF plug-in functions can also be remotely programmed through the mainframe circuits.

Service information, descriptions, and operating instructions for the various plug-in sections are provided in separate manuals.

1-10. EQUIPMENT AVAILABLE

A service kit, HP 11672A, is recommended for servicing and adjusting the mainframe and the plug-in sections. Contents of the service kit are listed in Table 1-2. Individual items in the kit may be ordered separately if desired.

Table 1-1. HP 8660D Specifications (1 of 2)

Electrical Characteristics	Description
Frequency Selection	Keyboard control panel allows selection of CW (or center frequency) by entry keys or synthesized tuning dial. The least significant digit is 1 Hz*
Reference Oscillator	<p>Internal: 10 MHz quartz oscillator. Aging rate less than $\pm 3 \times 10^{-9}$ /24 hours after 30 day warmup (Standard).</p> <p>External: Rear panel switch allows operation from any 5 MHz or 10 MHz signal at a level between 0.5V and 2.5V rms into 170Ω. Stability and spectral purity will be partially determined by characteristics of external reference oscillator.</p>
Reference Output	<p>Rear panel BNC connector provides output of signal selected (INT. or EXT.) at the following levels into 170Ω :</p> <p>Internal Reference: 0.75V to 1.5 Vrms.</p> <p>External Reference: Nominally equal to external input.</p>
Display	Ten-digit numerical LED display of CW frequency is active in either local or remote mode unless the DISPLAY BLANK command has been programmed over the remote interface bus (HP-IB or BCD).
Synthesized Search	The Tuning dial increments the synthesized output frequency 60 steps per revolution (with the HP 86601A, the COARSE and STEP tuning are desensitized to 30 steps/revolution). Step sizes are 1 Hz, 1 kHz, 1 MHz, or any step size entered through the keyboard.
Digital Sweep	<p>Type: Symmetrical about CW/center frequency. Sweep width is divided into 100 synthesized steps for fastest sweep speed or 1000 steps for slower speeds or Manual Sweep.</p> <p>Sweep Width: Continuously adjustable over range of RF section installed. Smallest step size is equal to frequency resolution of mainframe.</p> <p>Sweep End Point Accuracy: Same as reference oscillator accuracy.</p> <p>Sweep Speed: Selectable 0.1 sec, 1 sec, or 50 sec per sweep (Auto or Single)</p> <p>Sweep Output: 0 to +8V stepped ramp, 100 or 1000 equal steps depending on sweep speed.</p> <p>Manual Sweep: Synthesized search dial allows manual sweep over width selected in 1000 steps (LED display follows output frequency during manual sweep).</p> <p>Single Sweep: Initiated by momentary contact key.</p>
Frequency Stepping	After a step size has been entered on the keyboard, depressing ↑ or ↓ button will increment frequency up or down by the desired step size. The knob can also be used to vary the frequency by that same step size.
Step Accuracy	Same as reference oscillator accuracy.
* When using 86603A RF section above 1300 MHz, least significant digit becomes 2 Hz.	

Table 1-1. HP 8660D Specifications (2 of 2)

Electrical Characteristics	Remote Programming *
Frequency	CW frequency is programmable over entire range with same resolution obtained in manual operation.
Frequency Step	↑ or ↓ may also be programmed to change the output frequency by a previously selected step size.
Output Level	Programmable in 1 dB steps over the output range of the RF section installed (for output level accuracy see RF section specifications).
Modulation	See specifications for modulation and RF section installed.
Programming Input	<p>Mating Connector Types:</p> <p>BCD interface; 36 pin Cinch type (supplied). HP-IB interface 24 pin Cinch type 57 (supplied with option 005).</p> <p>Logic:</p> <p>TTL compatible (negative true) "0" logic state corresponds to +2V or higher. "1" logic state corresponds to +0.8V or lower.</p>
Characteristics	General
Operating Temperature Range	0° to 55° C.
Leakage	Meets radiated and conducted limits of MIL STD 461B at frequencies above 100 kHz.
Power	100 or 120 Vac, +5 –10% at 48 to 440 Hz. 200 or 240 Vac, +5 –10% at 48 to 66 Hz. 400 VA maximum.
Weight	Signal Generator only: Net, 23.2 kg (51 lb), shipping 28.6 kg (63 lb).
* All functions controlled from the front panel, with the exception of the power switch and the knob, are programmable with the same accuracy and resolution as in manual mode.	

1-11. HOW TO USE THE RECOMMENDED TEST EQUIPMENT TABLE

Table 1-2 lists the test equipment and accessories required to test, adjust, and service the Signal Generator. The minimum specifications column describes the essential requirements for each piece of test equipment. Other equipment can be substituted if it meets or exceeds these minimum specifications.

Table 1-2. Recommended Test Equipment and Accessories List (1 of 2)

Item	Minimum Specifications	Suggested Model	Use*
Digital Voltmeter	Voltage Accuracy $\pm 0.02\%$ 0.000V to ± 40 Vdc	HP 3478A	A, S
AC RMS Voltmeter	1 μ V Sensitivity 0.05% of reading + 3 μ V accuracy	HP 3466A	A, S
Variable Voltage Transformer	Range 103 to 127 Vac Meter range 103-127-Vac ± 1 V	General Radio W4MT3A	A
Frequency Standard	Frequency 10 MHz Long Term Stability $< 1 \times 10^{-10}$ /24 hours	HP 5065A	P, A
Oscilloscope	Frequency dc to 50 MHz Time base 10 ns to 1s Time base accuracy 3%	HP 54200A	P, A, S
10:1 Divider Probes	10:1 Divider 10 Megohm 10 pF	HP 10014A (2)	
Spectrum Analyzer	Frequency Range 0.1 to 500 MHz	HP 8590A	A, S
Frequency Counter	Range 10 Hz to 500 MHz 1 Hz Resolution External Time Base Input	HP 5385A	A, S
Pulse Generator	Pulse Rate 100 kHz Pulse width 0.035 μ sec Amplitude 0.5V Polarity-Selectable	HP 8011A	A
Sweep Generator/ Test Oscillator	Frequency Range 10 Hz to 20 MHz Output Level -35 to +10 dBm	HP 3325A	A, S
RF Voltmeter	Range 0.1 to 2V Frequency Range 1 to 10 MHz	HP 3400A	P
50 Ω Feedthru Termination		HP 10100C	P
* Use: A = Adjustments; P = Performance Tests; S = Service			

Table 1-2. Recommended Test Equipment and Accessories List (2 of 2)

Item	Description	Model or Part Number	Use*
Service Kit	Consisting of: Adapter: BNC female to OSM male Adapter: BNC female, Seaelectro female Adapter: BNC female, Seaelectro female Adapter: Right angle OSM male/female Seaelectro jack (printed circuit mount) Adapter: Seaelectro Tee Tool: Adjustment Cable: Extender, 66 pin, gray Cable: Extender, 42 pin, gray Cable Assy: Seaelectro male/female, 24" long, gray Cable Assy: Seaelectro male/female right angle connectors, 24" long, red Cable Assy: Seaelectro right angle female, BNC male, 24" long, gray Cable Assy: Seaelectro male/female, 24" long, gray with blue stripe Cable Assy: White	HP 11672A HP 1250-1200 HP 1250-1236 HP 1250-1237 HP 1250-1249 HP 1250-1255 HP 1250-1391 HP 8330-0024 HP 11672-60001 HP 11672-60002 HP 11672-60005 HP 11672-60004 HP 11672-60003 HP 11672-60006 HP 11672-60008	A, S
* Use: A = Adjustments; P = Performance Tests; S = Service			

1
2
3
4
5
6
7
8
9
10
11
12
13
14
15
16
17
18
19
20
21
22
23
24
25
26
27
28
29
30
31
32
33
34
35
36
37
38
39
40
41
42
43
44
45
46
47
48
49
50
51
52
53
54
55
56
57
58
59
60
61
62
63
64
65
66
67
68
69
70
71
72
73
74
75
76
77
78
79
80
81
82
83
84
85
86
87
88
89
90
91
92
93
94
95
96
97
98
99
100

Section 2 INSTALLATION

2-1. INTRODUCTION TO THIS SECTION

This section provides the information needed to install the Synthesized Signal Generator. Included is information pertinent to initial inspection, power requirements, line voltage selection, power cables, interconnections, operating environment, remote selection, rack mounting, storage and shipment.

2-2. INITIAL INSPECTION

WARNING

To avoid hazardous electrical shock, do not perform electrical tests when there are signs of shipping damage to any portion of the outer enclosure (covers, panels, meters).

Inspect the shipping container for damage. If the shipping container or cushioning material is damaged, it should be kept until the contents of the shipment have been checked for completeness and the instrument has been checked mechanically and electrically. Procedures for checking electrical performance are given in Section 4. If there is mechanical damage or defect, incompleteness, or if the instrument does not pass the electrical performance test, notify the nearest Hewlett-Packard office. If the shipping container is damaged, or the cushioning material shows signs of stress, notify the carrier as well as the Hewlett-Packard office. Keep the shipping materials for the carrier's inspection.

2-3. PREPARATION FOR USE

Power Requirements

The Synthesized Signal Generator requires a power source of 100, 120, 220, or 240 Vac (+5% to -10%), 48 to 400 Hz. Power consumption is 400 VA maximum.

Line Voltage Selection

CAUTION

To prevent damage to the instrument make the line voltage selection BEFORE connecting the line power. Also, ensure the line power cord is connected to a line power circuit that is provided with a protective earth contact.

A rear panel line power module (A7), permits operation from 100, 120, 220, or 240 Vac. The number visible in the window (located on the module) indicates the nominal line voltage to which the instrument must be connected.

To prepare the instrument for operation, slide the fuse compartment cover to the left (the line power cable must be disconnected). Pull the handle marked FUSE PULL and remove the fuse; rotate the handle to the left. Gently pull the printed circuit voltage selector card from its slot and orient it so that the desired operating voltage appears on the top-left side (see Figure 2-1). Firmly push the voltage selector card back in its slot. Rotate the FUSE PULL handle to the right, install a fuse of the correct rating, and slide the fuse compartment cover to the right.

NOTE

For 110-120V line, use 4A slo-blo fuse, HP part number 2110-0635. For 220-240V line, use 2A slo-blo fuse, HP part number 2110-0303.

WARNING

This is a Safety Class I product (that is, provided with a protective earth terminal). An uninterruptible safety earth ground must be provided from the Mains power source to the product input wiring terminals, power cord, or supplied power cord set. Whenever it is likely that the protection has been impaired, the instrument must be made inoperative and be secured against any unintended operation.

BEFORE CONNECTING THIS INSTRUMENT, the protective earth terminals of this instrument must be connected to the protective conductor of the (Mains) power cord. The Mains plug shall only be inserted in a socket outlet provided with a protective earth contact. The protective action must not be negated by the use of an extension cord (power cable) without a protective conductor (grounding).

If this instrument is to be energized via an external autotransformer, make sure the autotransformer's common terminal is connected to the earthed pole of the power source.

CAUTION

For protection against fire hazard, the line fuse should only be a 250V normal blow fuse with the correct current rating.

Power Cable

This instrument is equipped with a three-wire power cable. When connected to an appropriate ac power receptacle, this cable grounds the instrument cabinet. The type of power cable plug shipped with each instrument depends on the country of destination. Refer to Table 2-1 for the part numbers of the power cables available.

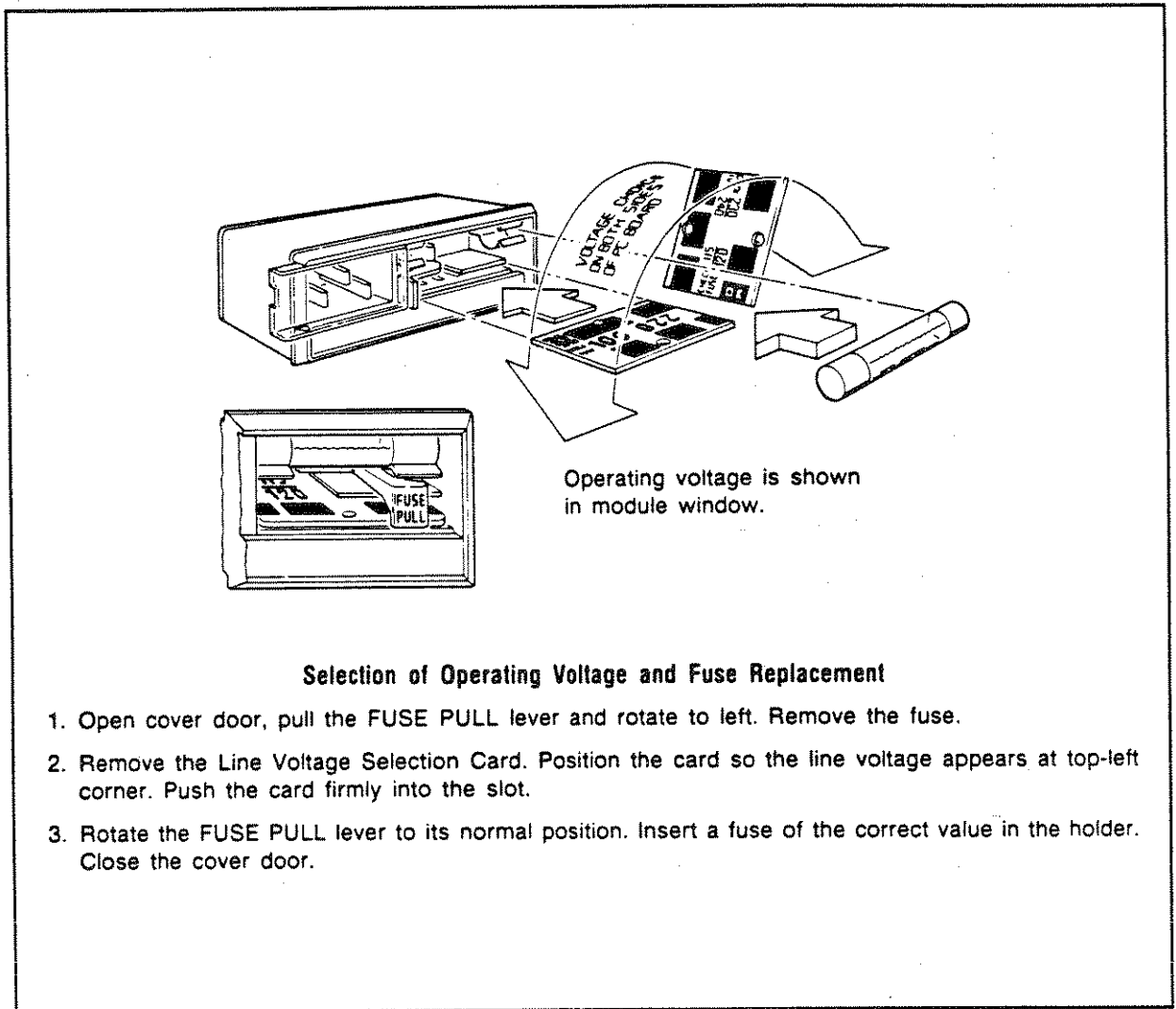

Figure 2-1. Line Voltage and Fuse Selection

Operating Environment

The operating environment should be within the following limitations:

Temperature	-0°C to +55°C
Humidity	<95% relative
Altitude	< 4600 meters (15 000 feet)

Clearances for airflow around the instrument should be as follows: 7.6 cm (3 in.) minimum clearance at the rear of the instrument and 2.5 cm (1 in.) minimum clearance on each side. The clearances provided by the plastic feet in bench stacking and the filler strip in rack mounting are adequate for the top and bottom cabinet surfaces.

Remote Selection

The HP 8660D is factory configured for BCD programming, or HP-IB programming (address=19) if option 005 is specified. If you are not sure what configuration the instrument is in, turn power on and press blue shift, 3 (display address). Either the letters "bcd" or the HP-IB address will be displayed.

The HP-IB address can be changed through front panel operation (see section 3) but upon power on or reset conditions it will always revert to the hardware setting on rocker switches found within the DCU module. The following procedure will allow you to change the HP-IB address or change programming format (HP-IB to BCD, or BCD to HP-IB).

WARNING

Setting of the HP-IB address should be performed only by service trained persons who are aware of the potential shock hazard of working on an instrument with protective covers removed.

To avoid hazardous electrical shock, the line (Mains) power cable should be disconnected before attempting to change the HP-IB address.

With the instrument in front of you, as if in operating position:

1. Make certain no power is connected to the instrument.
2. Remove the top cover.
3. Locate DCU module and trace power cable bundle (one black wire, one red/white wire, one white wire) from DCU module back to a connector mounted on the chassis. Remove the right side screw and pull the connector loose.
4. Remove the 2 ribbon cables from the DCU.
5. Rotate the instrument clockwise onto its right side.
6. Remove the bottom cover
7. To remove the DCU module, locate and remove 4 recessed screws fastening each corner of the DCU front to the chassis. (With the instrument up on its side screws are located on the right and left sides).
8. Slide the DCU out through the front of the instrument, and turn it upside down to further disassemble.
9. Remove 4 screws holding the DCU bottom cover and lift bottom cover up, exposing 3 circuit boards.
10. Remove the board furthest back, A1A5, by pulling straight up out of mounting connectors.

With the A1A5 board removed the HP-IB address can be changed, or the programming format can be changed by moving the blue jumper (to J3 for HP-IB or to J4 for BCD).

Rack Mounting (Option 908)

Rack mounting information is provided with the rack mounting kit. If the kit was not ordered with the instrument as an option, it may be ordered through the nearest Hewlett-Packard office. For rack-mount kit part numbers, refer to paragraph 1-8, "Options Available with the Instrument".









2-4. STORAGE AND SHIPMENT

Environment

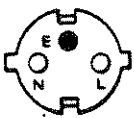
The instrument should be stored in a clean, dry environment. The following environmental limitations apply to both storage and shipment:

Temperature	-40°C to +75°C
Humidity	<95% relative
Altitude.....	<7600 meters (25 000 feet)

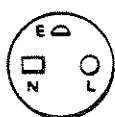
Table 2-1. AC Power Cables Available

Plug Type	Cable HP Part Number	C D	Plug Description	Cable Length (inches)	Cable Color	For Use In Country
250V 	8120-1351 8120-1703	0 4	Straight*BS1363A 90°	90 90	Mint Gray Mint Gray	United Kingdom, Cyprus, Nigeria, Rhodesia, Singapore
250V 	8120-1369 8120-0696	0 4	Straight*NZSS198/ASC112 90°	79 87	Gray Gray	Australia, New Zealand
250V 	8120-1689 8120-1692	7 2	Straight*CEE7-Y11 90°	79 79	Mint Gray Mint Gray	East and West Europe, Saudi Arabia, Egypt, (unpolarized in many nations)
125V 	8120-1378 8120-1398 8120-1754 8120-1378 8120-1521 8120-1676	5 5 7 1 6 2	Straight*NEMA5-15P 90° Straight*NEMA5-15P Straight*NEMA5-15P 90° Straight*NEMA5-15P	80 80 36 80 80 36	Black Black Black Jade Gray Jade Gray Jade Gray	United States, Canada, Mexico, Japan (100V or 200V), Philippines, Taiwan
250 V 	8120-2104	3	Straight*SEV1011 1959-24507 Type 12	79	Gray	Switzerland
250V 	8120-0698	6	Straight*NEMA6-15P			United States, Canada
220V 	8120-1957 8120-2956	2 3	Straight*DHCK107 90°	79 79	Gray Gray	Denmark
250V 	8120-4211	7	Straight*IEC83-B1	79	Black	South Africa, India
250V 	8120-1860	6	Straight*CEE22-VI (Systems Cabinet Use)			

*Part number shown for plug is industry identifier for plug only. Number shown for cable is HP Part Number for complete cable including plug.

E = Earth Ground; L = Line; N = Neutral

Packaging

Tagging for Service. If the instrument is being returned to Hewlett-Packard for service, please complete one of the blue repair tags located at the end of this manual and attach it to the instrument.

Original Packaging Containers and materials identical to those used in factory packaging are available through Hewlett-Packard offices. If the instrument is being returned to Hewlett-Packard for servicing, attach a tag indicating the type of service required, return address, model number and full serial number. Also mark the container FRAGILE to assure careful handling. In any correspondence refer to the instrument by model number and full serial number.

Other Packaging The following general instructions should be used for re-packaging with commercially available materials:

1. Wrap the instrument in heavy paper or plastic. (If shipping to a Hewlett-Packard office or service center, attach a tag indicating the service required, return address, model number, and full serial number.)
2. Use a strong shipping container. A double-wall carton made of 2.4 MPa (350 psi) test material is adequate.
3. Use enough shock-absorbing material (75 to 100 mm layer; 3 to 4 in. layer) around all sides of the instrument to provide firm cushion and prevent movement inside the container. Protect the front panel with cardboard.
4. Seal the shipping container securely.
5. Mark the shipping container FRAGILE to assure careful handling.

Section 3 OPERATION

3-1. INTRODUCTION TO THIS SECTION

This section provides operating instructions for the Hewlett-Packard Model 8660D Synthesized Signal Generator mainframe for both the local and remote modes.

The Model 8660D is designed to be used with plug-in sections that provide the selected output frequency with the chosen modulation parameters. Having access to the operating manuals for the plug-in sections you are using might make it easier to learn complete instrument operation.

NOTE

If a Modulation Plug-In Section is not used, it will be necessary to have an HP 86631B Auxiliary Section in place of the Modulation Section. The Auxiliary Section completes a signal path from the mainframe to the RF Section Plug-In and also provides a means of modulating the RF Section from an external source.

3-2. PANEL FEATURES

Front and rear panel controls, indicators and connectors of the HP 8660D are shown in Figure 3-1, and their functions are described in the following table.

1	SINGLE SWEEP key. In the SINGLE mode, when pressed, causes the RF output to be swept, one time only across the range stored in the sweep register, at a speed determined by the sweep RATE key.
2	OUTPUT (0 to +8V). Provides a sweep ramp for use in external equipment (oscilloscopes, X-Y recorders, etc.) when operating in the swept mode.
3	SWEEP RATE key. Selects sweep rates as follows: FAST — 100 steps at 1 millisecond per step, MED — 1000 steps at 1 millisecond per step, and SLOW — 1000 steps at 50 milliseconds per step (functional only when in Single or Auto Sweep modes).
4	POWER STBY-ON switch. In the STBY position, with the instrument connected to the ac line source, the reference oscillator oven temperature is maintained at the operating temperature to avoid the necessity of allowing for a warm-up period each time the instrument is used.
5	CENTER FREQUENCY readout. Displays the output center frequency of the RF Section (when a frequency units annunciator is lit and is not flashing).
6	ANNUNCIATORS. Provide a visual display of mode of operation, crystal oven temperature and out-of-range frequency selection. A frequency display annunciator flashes if a frequency value is not transferred to a register (by pressing CF, Sweep Width, or Step).
7	TUNING. Works as specified in the MANUAL MODE descriptions. May also be used to set the RF output to any point within the limits stored in the sweep register when the SWEEP MODE key is set to MANUAL.

8	<p>MANUAL MODE. Works in conjunction with the TUNING control to step the RF output in steps of 1 Hz (FINE), 1 kHz (MED), and 1 MHz (COARSE). In the STEP position the TUNING control steps the RF output frequency by the step stored in the instrument.</p>
9	<p>DATA KEYS. Contains 20 keys which are used to enter data or instructions as follows:</p> <p>Numerals 0 through 9 Decimal Point (.) ← ■ Clears last data entry. GHz, MHz, kHz, and Hz select frequency in conjunction with numeric keys. CF transfers keyboard storage register data to the center frequency register. ↑ transfers keyboard storage register data to the step register or steps the center frequency up when keyboard data is not present on the display. ↓ Same as ↑ except that frequency is stepped down. SWEEP WIDTH transfers keyboard storage register data to sweep register.</p>
10	<p>SHIFT. Blue SHIFT key lights up amber annunciator when pressed. At this time any one of the following shifted functions (blue key labels) can be selected.</p> <p>RESET sets instrument to power up state.</p> <p>CF = 1 MHz Sweep Width = 2 MHz Step = 5 MHz HP-IB Addr = 19 (or value selected by internal dip switches) Sweep Functions: Off Manual Step Mode: Off</p> <p>ERROR will redisplay error codes 01-05 (Refer to Error Codes.) SET ADRS allows HP-IB address (0-30) to be entered into volatile memory. Power down or instrument reset will cause the address to revert back to the manually set switch address. DISPLAY ADRS displays current HP-IB address or BCD if BCD is selected. LOCAL allows keyboard entry of data during remote programming (returns instrument to the local mode). CLEAR KYBD causes display to revert to center frequency. DISPLAY ↑ or ↓ displays step size. DISPLAY SWEEP WIDTH displays sweep width.</p>
11	<p>SWEEP MODE key. With the sweep mode switch in the AUTO position, sweep operation is automatic; the RF output is swept continuously about the center frequency by the data stored in the sweep register at the rate selected by the SWEEP RATE key. In the SINGLE mode, the RF output is swept once each time the SINGLE key is pressed. In the MANUAL mode, the sweep is controlled by the MANUAL TUNE control and the data stored in the sweep register.</p>
12	<p>LINE MODULE. Contains a means of switching input line voltage to 100/120/220/240 Vac +5% -10%, fuse, line cable connector and filtering. NOTE: The cabinet (earth) ground is also applied through the line module.</p>
13	<p>REFERENCE INPUT. Used when an external standard of 5 or 10 MHz is used.</p>
14	<p>REFERENCE OUTPUT. Provides the capability of using the internal reference as a time base in external equipment.</p>
15	<p>SELECTOR. Selects INT or EXT reference.</p>
16	<p>REMOTE INPUTS. When the instrument is operated in the remote mode, all functions of the instrument are controlled by the remote programming device. Front panel controls (except for LINE STBY-ON) have no effect on operation of the instrument.</p>

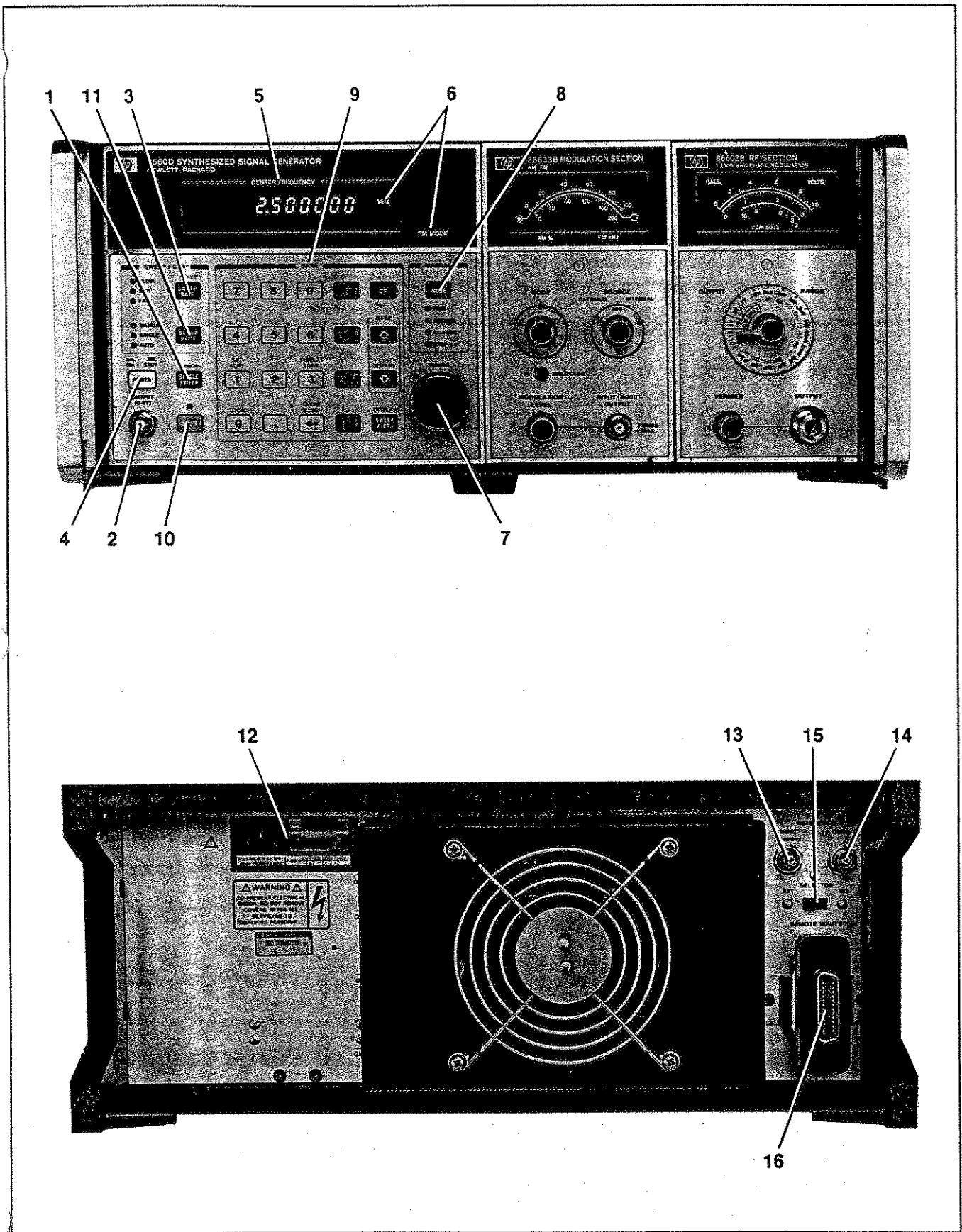

Figure 3-1. Front and Rear Panel Features

3-3. OPERATOR'S MAINTENANCE

Operator's maintenance of the HP 8660D Synthesized Signal Generator mainframe is limited to fuse replacement.

3-4. OPERATING PRINCIPLES

The HP 8660D may be operated by front panel controls in the local mode or externally programmed in the remote mode. Allow the system to warm up for 15 minutes before operating.

WARNING

The power requirements and safety precautions listed throughout this manual must be observed to preserve the built-in safety features of the HP 8660D.

3-5. LOCAL OPERATION

In the local mode of operation, all functions of the mainframe are controlled by front panel controls, except when an external reference oscillator is used. When an external reference oscillator is used, the rear panel SELECTOR switch must be in the EXT position.

The 25-key keyboard may be used to:

1. Select any frequency within the range of the RF Section plug-in in 1 Hz increments (above 1300 MHz, 2 Hz increments).

NOTE

When a center frequency is keyed in on the HP 8660D, the frequency is displayed and the units (GHz, MHz, kHz, Hz) annunciator flashes. Upon keying in CF, the frequency is accepted or rejected. If the entered frequency is above the upper limit of the RF Section (plug-in) being used, the readout reverts back to the last valid entry. If the frequency being entered is below the minimum frequency limit, the frequency is displayed but the RANGE annunciator comes on, indicating that the output amplitude may be degraded.

2. When frequencies below the RF Section frequency range are selected, the RANGE lamp lights.
3. Select any desired sweep width within the frequency range of the RF Section in use.
4. Select any incremental step within the frequency range of the RF Section in use.

Sweep Functions

The sweep width is selected by entering a frequency, then pressing **SWEEP WIDTH**. The sweep width may be displayed on the **CENTER FREQUENCY** readout by pressing the blue **SHIFT** key and then the **SWEEP WIDTH** key.

When the **SWEEP MODE** key is in the **AUTO** mode the output signal of the RF Section is swept about the selected center frequency by the selected sweep width. (Example: With the center frequency at 50 MHz and the sweep width at 20 MHz, the RF output is swept from 40 to 60 MHz.) The sweep rate, selected by the **SWEEP RATE** key is as follows: **FAST** - 100 steps at 1 millisecond per step, **MED** - 1000 steps at 1 millisecond per step and **SLOW** - 1000 steps at 50 milliseconds per step.

When the **SWEEP MODE** key is in the **SINGLE** mode, pressing the **SINGLE SWEEP** key causes the output of the RF Section to be swept one time. When the single sweep is completed, the output of the RF Section returns to the selected center frequency. The sweep width and sweep rate are selected in the same manner as they are in the **AUTO** mode.

Manual Tuning

When the **SWEEP MODE** key is in the **MANUAL** position, the output frequency of the RF Section may be manually controlled by the **TUNING** knob. In this mode the sweep width is still controlled by the information in the sweep register. The selected sweep width in this mode is divided by 1000 and the output of the RF Section may be controlled in frequency steps that are 1/1000 of the sweep width. (Example: with a 50 MHz center frequency and a 20 MHz sweep width, output may be swept manually from 40 to 60 MHz in 20 kHz steps.)

The center frequency may be stepped up or down in any increment within the frequency range of the RF Section in use. Enter the desired increment and units, then press **STEP** ↑ or **STEP** ↓. The increment entered into the step register remains in the register until changed (or the instrument is reset or placed in standby mode) and may be displayed on the readout by pressing the blue **SHIFT** key, then the **STEP** ↑ or **STEP** ↓ key.

MANUAL MODE can be used for changing the center frequency. Choose **STEP** mode and the **TUNING** knob will increment the frequency by the same value stored in the **STEP** register.

The other increments selected by the **MANUAL MODE** key are 1 Hz (**FINE**), 1 kHz (**MED**), and 1 MHz (**COARSE**).

3-6. OPERATOR'S CHECKS

NOTE

If the instrument is returned for service, be sure to attach a blue repair tag (located at the end of this manual) with failure information.

During final checkout at the factory the HP 8660D Synthesized Signal Generator mainframe is adjusted for proper operation. No adjustments should be required when the instrument is received. The following operator's checks are based on the assumption that properly operating RF Sections and Modulation Sections are in place during the tests. Refer to the manuals for the specific plug-ins for operating parameters.

The steps listed in the Operator's Checks need not be followed in the sequence listed. Their purpose is to aid operators in familiarizing themselves with the instrument, and to provide assurance that all functions of the instrument are operating properly.

Many of the tests specified in the Operators checks do not apply specifically to an RF Section (plug-in). Those checks which do not refer to a specific RF Section apply equally to the HP 86601, HP 86602, and HP 86603. When procedures apply to specific RF Sections only, this information is conveyed in the procedure.

NOTE

Any operator's checks specified in the plug-in manuals should also be performed.

Initial Turn-On Check

1. Set the rear panel line select switch in the line power module to be compatible with the available line power (refer to Section 2).
2. Connect the instrument to the power outlet; use ground pin adapter for electrical systems having no ground outlet.

NOTE

The instrument should remain connected to the power source in the STBY (standby) mode when not in use. This will maintain a constant temperature in the crystal oven and eliminate the need for a warmup period.

3. Place the **POWER** key (STBY/ON) in the ON position. Allow the system to warm up for 15 minutes before operating.

The cooling fan should start and the display should read 1.000000 MHz.

Keyboard Register and Readout Checks.

1. Enter 1.234567890. Note that readout input steps from right to left.
Units annunciators (GHz, MHz, kHz, Hz) should be off and the display should read 1.234567890.
2. Press **GHz** key.
The display should read: 1.234567890 GHz (Units annunciator flashing).
3. Press **MHz** key.
The display should read: 1.234567 MHz (Units annunciator flashing).
4. Press **kHz** key.
The display should read: 1.234 kHz (Units annunciator flashing).
5. Press **Hz** key.
The display should read: 1 Hz (Units annunciator flashing).
6. Press the **←** key.
The display should read: 1.000000 MHz.
7. Press 1.
 - a. Press the **kHz** key.
The display should read: 1.000 kHz (Units annunciator flashing).
 - b. Press the **MHz** key.
The display should read: 1.000000 MHz (Units annunciator flashing).
 - c. Press the **GHz** key.
The display should read: 1.000000000 GHz (Units annunciator flashing).
 - d. Press the **SHIFT** key and then the **←** key.
The display should read: 1.000000 MHz.

Step ↑ ↓ Register and RANGE Annunciator Check Using the HP 86601 RF Section.

1. Enter 109 MHz and press **CF** on the keyboard.
The display should read: 109.000000 MHz.
2. Enter 111111 Hz and press **STEP ↑** key.
The display should read: 109.000000 MHz.
3. Press the **SHIFT** key and then the **STEP ↓** key.
The display should read: 111111 Hz, momentarily, then return to 109.000000 MHz.

4. Press the **STEP** ↑ key until the readout shows 109.999999 MHz. Note that the readout increments in 111111 Hz steps .
5. Press the **STEP** ↑ key one more time.
The RANGE annunciator should flash once.
6. Press the **MANUAL MODE** key four times to put manual tuning in STEP mode and turn the TUNING knob counterclockwise. The value in the display should decrement in 111111 Hz steps.
7. Enter 10 kHz and press the **CF** key.
The display should read: 10.000 kHz.
8. Enter 1 Hz and then press the **STEP** ↑ key.
The display should read: 10.000 kHz.
9. Press the **STEP** ↓.
10. With the Model 86601A RF Section the specified lower frequency limit is 10 kHz, therefore, the RANGE light should stay on.

NOTE

The Model 86601A RF Section lower frequency limit is specified at 10 kHz. The output frequency is accurate down to 1 Hz and the output power level is typically accurate down to 3 kHz or less. However, the output signal should be considered unusable below 1.5 kHz.

11. Enter 3 kHz CF on the keyboard.
The display should read: 3.000 kHz, the RANGE light should be on.
12. Enter 100 Hz **STEP** ↓.
The display should read: 3.000 kHz.
13. Repeatedly press the **STEP** ↓ key. Note that the CF readout decreased in 100 Hz steps. The RF output level will typically start to drop when the frequency drops below 2 kHz. Also, the RANGE light will remain on.

STEP ↑↓ Register and RANGE Annunciator Check with the 86602A RF Section.

1. Enter 1200 MHz CF on the keyboard.
The display should read: 1.200000000 GHz.
Enter 11.111111 MHz **STEP** ↑
2. Press **STEP** ↑ until display reads: 1.299999999 MHz.
3. Press the **STEP** ↑ key one more time.
The display should read: 1.299999999 GHz and the RANGE light should flash once.
4. Repeatedly press the manual **MODE** key until manual tuning is in STEP mode, and turn the TUNING CONTROL counterclockwise.
The readout should decrease in 11.111111 MHz steps.

5. Enter 1 MHz CF on the keyboard.
The display should read: 1.000000 MHz.
6. Enter 1 Hz **STEP** ↑ on the keyboard. Press SHIFT key. Press the **STEP** ↓ key.
The display should read: 1 Hz, momentarily, then return to 1.000000 MHz.
7. Press **STEP** ↓ key. The RANGE light should come on.

STEP ↑↓ Register and RANGE Annunciator Check with the 86603A RF Section.

1. Enter 2500 MHz CF on the keyboard.
The display should read: 2.500000000 GHz.
2. Enter 11.111111 MHz **STEP** ↑ on the keyboard.
The display should read 2.500000000 GHz.
3. Press **STEP** ↑ until the readout displays: 2.599999998 GHz.

NOTE

The frequency increase alternates between 11.111110 and 11.111112 MHz due to the 2 Hz resolution of center frequencies ≥ 1300 MHz.

4. Press the **STEP** ↑ key one more time.
The display should read: 2.599999998 MHz and the RANGE light should flash once.
5. Repeatedly press the manual MODE key until manual tuning is in STEP mode. Turn the TUNING CONTROL counterclockwise.
The readout decrease is in 11.111110 or 11.111112 MHz steps down to 1300 MHz. When the frequency gets below 1300 MHz, it will decrease in 11.111111 MHz steps (down to a minimum of 25 Hz).
6. Enter 1 MHz CF on the keyboard. Enter 1 Hz **STEP** ↑ on the keyboard.
The display should read: 1.000000 MHz.
7. Press the **STEP** ↓ key.
The display should read: 999.999 kHz and the RANGE light should stay on.

Manual Mode - Manual Tuning Check (With 86601A)

NOTE

The upper frequency limit for 86602A/B RF Section is 129.999999 MHz; for 86603A, 2599.999998 MHz

1. Set SWEEP MODE off (no annunciators lit) and enter 0 MHz CF.
Display should read: 0 Hz and RANGE light is on.
2. Repeatedly press the manual MODE key until Manual Mode is set to COARSE and rotate the TUNING control clockwise until the readout indicates: 109.000000 MHz. Note that the readout steps in 1 MHz increments.
3. Repeatedly press the manual MODE key until Manual Mode is set to MED and rotate the TUNING control clockwise until the readout indicates: 109.999000 MHz. Note that the readout steps in 1 kHz increments.

4. Repeatedly press the manual **MODE** key until Manual Mode is set to **FINE**, then rotate the **TUNING** control clockwise until the readout indicates: 109.999999 MHz. Note that the readout steps in 1 Hz increments.

NOTE

The RANGE light flashes on if the RF Section upper frequency limit (109.999999 MHz) is passed. The system rejects overrange frequencies and the CF register retains the last valid entry.

Sweep Mode Checks with 86601A RF Section**NOTE**

Proper operation of the instrument in the sweep mode is best verified with a spectrum analyzer. However, operation of the sweep function can be verified by front panel indications in steps 1 and 2. Also, when the RANGE light comes on during these checks, it is because the frequency has dropped below the lower frequency limit of 10 kHz.

1. Set CF to 5 kHz. Enter 10 kHz and press **SWEEP WIDTH**. Place **SWEEP MODE** in the **AUTO** position and the **SWEEP RATE** in **MED** position. The **SWEEP** and **RANGE** lights should be on.
2. Set CF to 10 kHz. The **SWEEP** light should remain lit. **RANGE** light should flash every second.
3. Connect the RF output to the RF INPUT of the spectrum analyzer. Enter 10 MHz CF and 10 MHz **SWEEP WIDTH** and set the **SWEEP MODE** to **AUTO**. Set the **SWEEP RATE** to **MED** and adjust the spectrum analyzer for a clear display. Enter 5 MHz **STEP** and step the frequency across the RF range. The readout should increase in 5 MHz steps. Sweep should continue to be 5 MHz on each side of the CF.

Sweep Mode Checks with 86602A, 86602B or 86603A RF Sections**NOTE**

When the RANGE light comes on during the HP 86602/HP 86603 checks, it is because the frequency has dropped below the lower frequency limit of 1 MHz.

1. Set CF to 5 MHz. Set **SWEEP WIDTH** to 10 MHz. Set **SWEEP MODE** to **AUTO** and **SWEEP RATE** to **MED**.

Display should read: 5.000000 MHz, and the **RANGE** light will flash every second. RF Section meter also will dip, and **SWEEP** light will remain on.

2. Set **SWEEP WIDTH** to 2 MHz. Set CF to 1 MHz.

The display should read: 1.000000 MHz with **SWEEP** light on. The **RANGE** light will flash every second.

3. Set CF to 5 MHz on the keyboard. Set **SWEEP WIDTH** to 10 MHz. Set **SWEEP RATE** to **MED**.

Display should read: 5.000000 MHz, and the **RANGE** light will flash every second.

Manual Sweep Check

1. Enter 50 MHz CF and 10 MHz SWEEP WIDTH. Place the SWEEP MODE in the MANUAL position. Rotate the TUNING control knob through its range. Note that CF is tuneable from 40 to 55 MHz.

Single Sweep Check

1. Enter 50 MHz CF and 20 MHz SWEEP WIDTH and place the SWEEP MODE in the SINGLE position. Connect the RF output to the RF INPUT of the spectrum analyzer to display the 50 MHz signal. Press the SINGLE SWEEP key.

Display should read: 50.000000 MHz. The spectrum analyzer display is swept once from 40 to 60 MHz.

Modulation Plug-ins

Since the modulation plug-ins are not affected by the mainframe except for digital control signals, operator's checks for the modulation plug-ins are not included in the Operator's Checks. Refer to the individual manuals for the modulation plug-in operator's checks.

3-7. ERROR CODES

Table 3-1 explains the meaning of all error codes the HP 8660D Digital Control Unit (DCU) is programmed to output. Note that errors 01-05 can be redisplayed by pressing the blue **SHIFT, ERROR**.

3-8. HP-IB PROGRAMMING; "OLD" AND "NEW" CODES EXPLAINED

The HP 8660D features a new DCU section which recognizes two versions of HP-IB code. The version used by the HP 8660A, HP 8660B and HP 8660C is termed "OLD". It is the only code recognized by the HP 8660D after being powered up or reset, or when the command "OLD" is sent via HP-IB.

An extended version of HP-IB codes is termed "NEW", and these codes are the only ones that can be used after the command "NEW" is sent. The "NEW" codes can also be used when adding to existing programs which may contain "OLD" codes. Simply send the command "NEW" for code being added, and send the command "OLD" before the program goes back to a section of "OLD" code.

The advantages of the "NEW" over the "OLD" programming code includes:

- Frequency units of GHz, MHz, kHz, and Hz are used. No conversion to Hz necessary.
- No digit reversal required.
- Desired output level is entered directly in +dBm or -dBm. No adjustment is needed to compensate for a +13 dBm reference level.
- Programming syntax is consistent with other HP signal generators currently being manufactured.

Table 3-1. Error Codes

Error	Description
01	This error occurs when an error is detected during power-up RAM TEST (can be redisplayed by pressing the blue SHIFT, ERROR).
02	This error occurs when an error is detected in ROM Checksum during power-up (can be redisplayed by pressing the blue SHIFT, ERROR).
03	This error occurs when a Read error occurs during the Read/Write test of the instrument interface PIA (A1A3U8) ports during the power-up Self Test (can be redisplayed by pressing the blue SHIFT, ERROR).
04	This error occurs when a Read error is detected during the Read/Write check of the BCD Interface PIA (A1A5U7) during the power-up Self Test (can be redisplayed by pressing the blue SHIFT, ERROR).
05	This error occurs when in the Sweep Mode and the Sweep Width has been selected such that it will cause the CW to sweep to a Frequency below 0 Hz or above the maximum output frequency of the RF plug-in. (can be redisplayed by pressing the blue SHIFT, ERROR).
06	This error occurs when an HP-IB address that is > 30 is input via the keyboard.
07	This error occurs when an unrecognized command or ASCII character is received over the GPIB while in the "OLD" programming format.
08	This error occurs when an unrecognized command or ASCII character is received over the GPIB while in the "NEW" programming format.
09	<p>This error occurs only in the HP-IB "NEW" programming format when an output level which is out of the respective plug-in's output range is programmed over the GPIB. This error condition aborts the command.</p> <p style="text-align: center;">NOTE <i>The Output Level is programmed with a maximum of three significant digits.</i></p>
0A	<p>This error occurs only in the HP-IB "NEW" programming format when a modulation level which is out of range for the specified modulation type is programmed over the GPIB. (For example, AM > 99 PC, PM > 99 DG, FM > 990 Kz, or FM < 0.1 kZ.)</p> <p style="text-align: center;">NOTE <i>Modulation is programmed with a maximum of three significant digits.</i></p>

3-9. SIGNAL GENERATOR FUNCTION TO "NEW" HP-IB CODES

Table 3-2 organizes the HP 8660D operating functions to their corresponding HP-IB "NEW" programming codes.

Table 3-2. HP-IB "NEW" Code Summary

Function	Code	Function	Code
FREQUENCY		MODULATION SOURCE	
Center Frequency	FR	Internal 1 kHz	M1
Frequency Step Up	UP	Internal 400 Hz	M2
Frequency Step Down	DN	Internal dc-Coupled	M4
Increment Set	(FR)IS	External ac-Coupled	M8
		External ac-Coupled Unleveled	M9
AMPLITUDE		SWEEP	
Output Level	AP	Sweep Width	FS
MODULATION		Sweep Mode:	
FM Deviation	FM ¹	Sweep Off	WO
AM Depth	AM ²	Auto Sweep	W1
ΦM Deviation	PM ³	Single Sweep	W2
Modulation Off	MO	Single Sweep Trigger	W3
Modulation Level	PC		
FM Calibration	FC	Sweep Rate:	
Modulation Degrees	DG	SL	T1
FM÷2	CN ⁴	MED	T2
		FAST	T3
DISPLAY		UNITS	
Blank CF Display	DB	GHz	GZ
Output CF Display	DO	MHz	MZ
MISCELLANEOUS		kHz	KZ
HP-IB "OLD" Mode	OLD	Hz	HZ
HP-IB "NEW" Mode	NEW	+dBm	+dm
Register Clear	/	-dBm	-dm

¹ FM code must be followed by up to 3 digits of FM deviation, followed by the units. For example, FM150KZ.

² AM depth must be programmed using PC (%).

³ ΦM depth must be programmed using DG (°).

⁴ If CN is not programmed in when the modulation section is 86632B, or 86635A, the FM or AM modulation will be twice the value programmed.

3-10. HP-IB CAPABILITIES

Refer to the following table for a synopsis of HP-IB operations the HP 8660D is capable of performing.

Table 3-3. HP-IB Capabilities

HP-IB Capability	Applicable	Response	Related Commands and Controls*	Interface Functions*
Data	Yes	All Front-Panel functions and Remote only functions are programmable (except knob rotation and all shift key functions excluding LOCAL).	MLA, EOI	T6, AH1, SH1
Trigger	No	The Signal Generator does not have a device trigger capability.	GET	DT0
Clear	No	The Signal Generator does not respond to the DCL or SDC bus commands	DCL, SDC	DC1
Remote	Yes	The Signal Generator's Remote mode is enabled when the REN bus line is true. However, it remains in local (that is, the keyboard is active) until it is first addressed to listen. The RF output power level goes to its minimum level upon entering the remote mode. The front-panel REMOTE indicator turns on when in the remote mode.	RNA, MLA	RL1
Local Lockout	Yes	The Signal Generator responds to the LLO bus command.	LLO	RL1
Clear lockout/Set local	Yes	The Signal Generator returns to the local mode when the REN bus line goes false.	REN	RL1
Pass control/Take control	No	The Signal Generator does not pass or take control of the HP-IB bus.	ATN, IFC	C1, C2, C3, C28
Require Service	No	The Signal Generator does not activate the SRQ bus line.	SRQ	SR1
Status Byte	No	The Signal Generator does not respond to a serial poll enable.	SPE, SPD, MTA	T6
Status Bit	No	The Signal Generator does not respond to a parallel poll enable.	ATN, EOI	PPO
Abort	Yes	The Signal Generator stops listening.	IFC	T6, L3
<p>* Commands, Control lines and Interface Functions are defined in IEEE Std 488 (and the identical ANSI Standard MC1.1). Knowledge of these might not be necessary if your controller's manual describes programming in terms of the twelve HP-IB Messages shown in the left column.</p> <p>Complete HP-IB capability as defined in IEEE Std 488 (and the identical ANSI Standard MC1.1) is: SH1, AH1, T6, TE0, L3, LE0, SR1, RL1, PP0, DC1, DT0, C1, C2, C3, C28, E2.</p>				

3-11. EXAMPLE PROGRAM

This program is written in BASIC for the HP 9826 computer. The program will display a menu of softkey selections which allow you to enter frequency, modulation, amplitude, frequency step, and go to local or remote operation.

You must have a modulation plug-in (HP 86632B or HP 86635A) and any RF section plug-in to use all the features of the program.

Once the program is loaded and running, press remote to display softkey selection.

```

10      !
20      !
30      !   COMPUTER CONTROL OF THE
40      !   HP 8660D
50      !   USING THE 9826
60      !
70      ! RESTORE "TEST60D"
80      !
90      DIM Input$(6),Step_size$(11)
100     DIM Center_freq$(11),Rf_level$(4)
110     DIM Modulation$(6),Mod_source$(1)
120     !
130     CLEAR 7
140     !
150     Local_operation:      !   Enable local mode and give user choice of stopping
160     LOCAL 719            !   program or going into remote mode.
170     OFF KEY
180     ON KEY 3 LABEL "STOP" GOTO Stop_pgm
190     ON KEY 8 LABEL "REMOTE" GOTO Remote
200     GOTO 200
210     !
220     Remote:              !   Enable remote mode and set 8660D to new programming
230     REMOTE 7             !   mode. Provide softkey selection of frequency,output
240     OUTPUT 719;"NEW"    !   level,modulation,step size,step up,step down,and
250     OFF KEY              !   local modes.
260     ON KEY 0 LABEL "FREQ" GOSUB Center_freq
270     ON KEY 1 LABEL "MOD" GOSUB Modulation
280     ON KEY 5 LABEL "LEVEL" GOSUB Rf_level
290     ON KEY 7 LABEL "S SIZE" GOSUB Set_step_size
300     ON KEY 3 LABEL "UP" GOSUB Step_up
310     ON KEY 4 LABEL "DOWN" GOSUB Step_down
320     ON KEY 8 LABEL "LOCAL" GOTO Local_operation
330     GOTO 330
340     !
350     Center_freq:        !   Input and program center frequency.
360     DISP "Enter center frequency in MHz";
370     INPUT Center_freq$
380     GOSUB Set_center_freq
390     RETURN
400     !
410     Rf_level:          !   Input and program RF level.
420     DISP "Enter Rf level in dBm";
430     INPUT Rf_level$
440     GOSUB Set_rf_level
450     RETURN
460     !
470     Modulation:        !   Input type of modulation desired and enable
480     !                   !   softkey selection.
490     DISP "Enter type of mod: AM, FM, PHASEM or none";
500     INPUT Modulation$
510     IF Modulation$="AM" THEN
520     ON KEY 6 LABEL "AM" GOSUB Am
530     GOSUB Am
540     RETURN

```

```

550     END IF
560     IF Modulation$="FM" THEN
570         ON KEY 6 LABEL "FM" GOSUB Fm
580         GOSUB Fm
590         RETURN
600     END IF
610     IF Modulation$="PHASEM" THEN
620         ON KEY 6 LABEL "PHASEM" GOSUB Phasem
630         GOSUB Phasem
640         RETURN
650     END IF
660     IF Modulation$="none" THEN
670         OUTPUT 719;"MO"
680         OFF KEY 6
690         RETURN
700     END IF
710     GOTO Modulation
720     !
730     Am:           !           AM modulation selected.Enter desired AM depth.
740     DISP "Enter AM depth in percent";
750     INPUT Modulation$
760     GOSUB Set_mod_source
770     GOSUB Set_am_depth
780     RETURN
790     !
800     Fm:           !           FM modulation selected.Enter desired FM deviation.
810     DISP "Enter FM deviation in kHz";
820     INPUT Modulation$
830     GOSUB Set_mod_source
840     GOSUB Set_fm_dev
850     RETURN
860     !
870     Phasem:       !           Phase modulation selected.Enter desired Phase
880                 !           deviation.
890     DISP "Enter phase deviation in degrees";
900     INPUT Modulation$
910     GOSUB Set_mod_source
920     GOSUB Set_pm_dev
930     RETURN
940     !
950     Stop_pgm:     !
960     STOP
970     !
980     Set_mod_source: !           Enter the type of modulation source desired:
990                 !           internal 1000 Hz,internal 400 Hz,external DC,
1000                !           external AC,or external AC unlevelled.
1010     Input$=""
1020     Mod_source$="0"
1030     Enter_source: DISP "Enter Source: I1000,I400,EDC,EAC,EACU";
1040     INPUT Input$
1050     IF Input$="I1000" THEN Mod_source$="1"
1060     IF Input$="I400" THEN Mod_source$="2"
1070     IF Input$="EDC" THEN Mod_source$="4"
1080     IF Input$="EAC" THEN Mod_source$="8"
1090     IF Input$="EACU" THEN Mod_source$="9"
1100     IF Mod_source$="0" THEN GOTO Enter_source
1110     RETURN
1120     !
1130     Set_step_size: !           Input and program frequency step size.
1140     DISP "Enter step size in MHz";
1150     INPUT Step_size$
1160     OUTPUT 719;"IS";Step_size$;"Mz"
1170     RETURN
1180     !
1190     Step_up:       !           Program frequency step up.
1200     OUTPUT 719;"UP"

```

```

1210   RETURN
1220   !
1230   Step_down:      !           Program frequency step down.
1240   OUTPUT 719;"DN"
1250   RETURN
1260   !
1270   Set_center_freq: !           Output programmed center frequency to the 8660.
1280   OUTPUT 719;"FR";Center_freq$;"Mz"
1290   RETURN
1300   !
1310   Set_rf_level:   !           Output programmed RF level to the 8660.
1320   OUTPUT 719;"AP";Rf_level$;"dm"
1330   RETURN
1340   !
1350   Set_am_depth:   !           Output programmed AM depth to the 8660.
1360   OUTPUT 719;"M";Mod_source$;"AM";Modulation$;"PC"
1370   RETURN
1380   !
1390   Set_fm_dev:     !           Output programmed FM deviation to the 8660.
1400   OUTPUT 719;"M";Mod_source$;"FM";Modulation$;"KZ"
1410   RETURN
1420   !
1430   Set_pm_dev:    !           Output programmed Phase deviation to the 8660.
1440   OUTPUT 719;"M";Mod_source$;"PM";Modulation$;"DG"
1450   RETURN
1460   END

```

HP-IB Address Selection

The Signal Generator's address is set to 19 at the factory by an internal switch located inside the instrument. This address can be locally changed using either the front-panel function, SET ADRS, or the internal switch. The HP-IB address cannot be changed by remote command.

It is simpler to change the address from the front panel than from the internal switch. However, it is a more permanent change to change the address using the internal switch. The address set from the front panel reverts to the address set by the internal switch whenever the instrument is turned off, then on again.

Changing the Address from the Front Panel

Available addresses are from 00 to 30.

Example of changing the address to 15:

```
1 5 SET ADRS (SHIFT 1)
```

Changing the Address Using the Internal Switch

For a procedure for changing the address using the internal switch, refer to *Remote Selection* in Section 2 of this manual.

Further HP-IB Programming Information

For more information about HP-IB, refer to one or all of the following documents:

IEEE Standard 488-1978

ANSI Standard MC1.1

"Improving Measurements in Engineering and Manufacturing" (HP part number 5952-0058)(the Hewlett-Packard catalog of Electronic Systems and Instruments)

"Tutorial Description of the Hewlett-Packard Interface Bus" (HP part number 5952-0156)

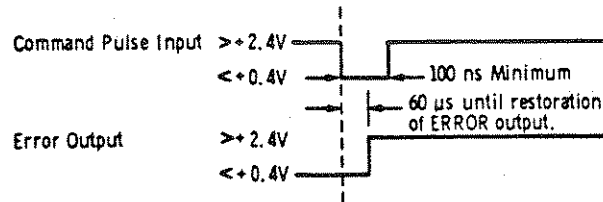
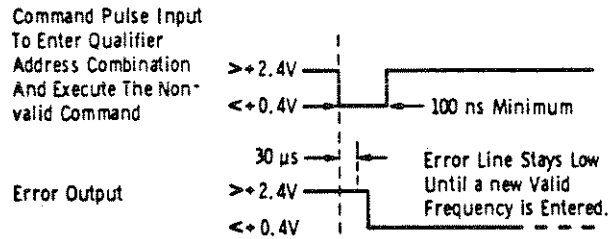
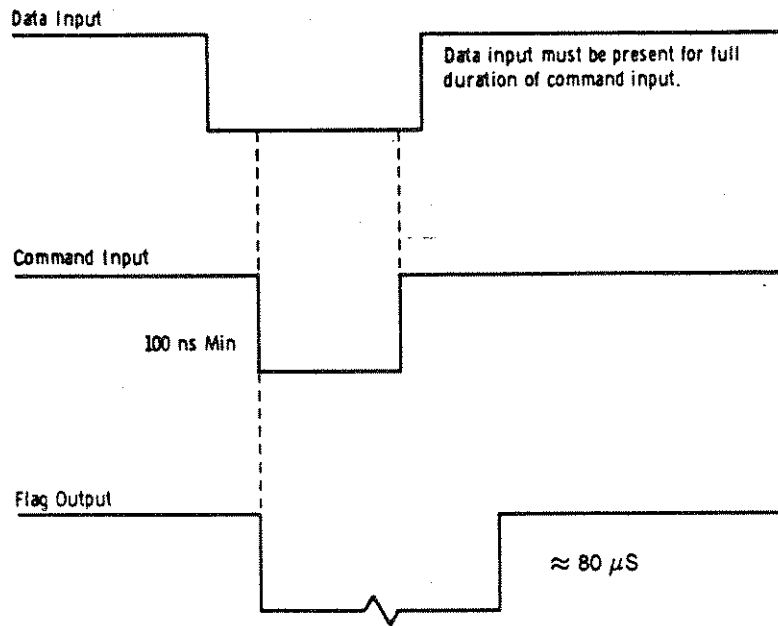

Figure 3-3. HP 8660D Data Input and Error Output Timing

Data Inputs

Data inputs (logic 1=0V) must be referenced to the command pulse as shown in Figure 3-3. The data inputs may be terminated after the command pulse trailing edge.

The command pulse causes the input data to be stored in the temporary storage register or, if the data input is an address, to be stored in one of the final storage registers. These pulses are logic 1 (0V) pulses of 100 nanoseconds minimum width, maximum frequency of 500 kHz. Pulses for low transfer frequencies may be wider if consistent with the duty cycle. The trailing edge must have a rise time of 100 nanoseconds or less. Transfer occurs on the trailing edge of the pulse. Note that data must be held until the command pulse terminates. The flag signal is also initiated by the falling (leading) edge of the command pulse.

Flag Signal

The flag signal indicates receipt and execution of the command pulse from the remote programming device. The flag signal will be logic 1 (0V). Duration of the signal will depend on the function programmed.

Reset

Controls the DCU circuits in the same manner as a front panel reset. Requires a logic 1 (0V) level which may be as short as 5 microseconds.

Table 3-4. Storage Register Addresses

Name of Register	Address 0=High, 1=Low	Location	Function
Center Frequency	0000 (0)	Mainframe	To Set Frequency
Step ↑	0001 (1)		To step center frequency up in any increment
↓ Step	0010 (2)	Mainframe DCU	To step center frequency down in any increment
Attenuator	0011 (3)	RF Section plug-in	Controls level of RF OUTPUT
AM-FM Function	0100 (4)	Modulation Section plug-in	Selects Modulation Function
AM-FM%	0101 (5)	Modulation Section plug-in	*Selects AM% of Modulation or FM Deviation
FM CAL 86632 or 86635 only	0110 (6)	Modulation Section plug-in	Phase locks 20 MHz FM oscillator to the reference loop 20 MHz

* The HP 86632B and the HP 86635A require inputs of one-half of the desired deviation in remote mode.

EXAMPLE 1. Set 100.000000 MHz Center Frequency (CF)

Input (0=High, 1=Low)	Temporary Register	CF Register
Data: D ₁ 0001 (1) D ₂ 0000(0)	00 00 00 00 00	Last Input
Temporary Command	01 00 00 00 00	Last Input
Address: D ₁ 1111 (15) D ₂ 0000(0)	01 00 00 00 00	Last Input
Transfer Command	00 00 00 00 00	01 00 00 00 00

For a detailed description of the Hewlett-Packard Interface Bus connector, refer to Figure 3-2.

For information regarding "OLD" HP-IB programming codes, refer to Programming Note HP part number 5953-8391, or the HP 8660 A, B, or C manuals.

3-12. BCD REMOTE OPERATION

NOTE

The following information pertaining to BCD programming, does not apply to HP-IB programming.

There are several conventions which must be observed when remotely controlling the 8660D using BCD code. Besides providing data with the least significant digit first, these conventions include:

1. All output levels are referenced to +13 dBm. This reference operation involves subtracting 13 from the desired output level.
2. There are three separate modulation parameters which may be programmed; source, type and %. Source and type are combined into one number (source is the least significant digit).
3. When in the remote mode, all front panel controls except the POWER and FM CAL controls and the SHIFT, POWER and LOCAL keys are inhibited.
4. Digital sweep may not be operated in the remote mode of operation.
5. When changing from the local to the remote mode of operation the temporary storage register should be cleared before a remote entry is made.
6. The data level inputs to the Model 8660D are as follows: approximately 0 volts TTL LOW = 1 and approximately 2.8 volts TTL HIGH = 0 (sometimes referred to as negative or ground true logic).

In BCD remote operation two four-bit parallel codes are applied to the instrument circuits through a rear panel connector (J3). These inputs, if numeric data, are converted to BCD digit serial information and clocked into a temporary storage register. If the inputs are address information they are used to direct a clock to strobe the data from the temporary storage register into the desired final storage register.

When all of the significant data entries have been stored in the temporary storage registers, the least significant digit is stored in a position to allow it to be the first digit strobed out, then the next least significant digit, etc, so that the information will be stored in the appropriate register in the same sequence in which it was received.

Operation of the storage registers not located in the HP 8660D mainframe is detailed in the manuals for the plug-in sections. Examples 1-7 provides examples of programming the registers which may be programmed when the HP 8660D mainframe is used.

Refer to Figure 3-3 for timing information and to Table 3-6 for interconnection information.

NOTE

Although it is not necessary to program frequency first, then modulation (if any), then attenuation, this sequence minimizes the time required for entering data.

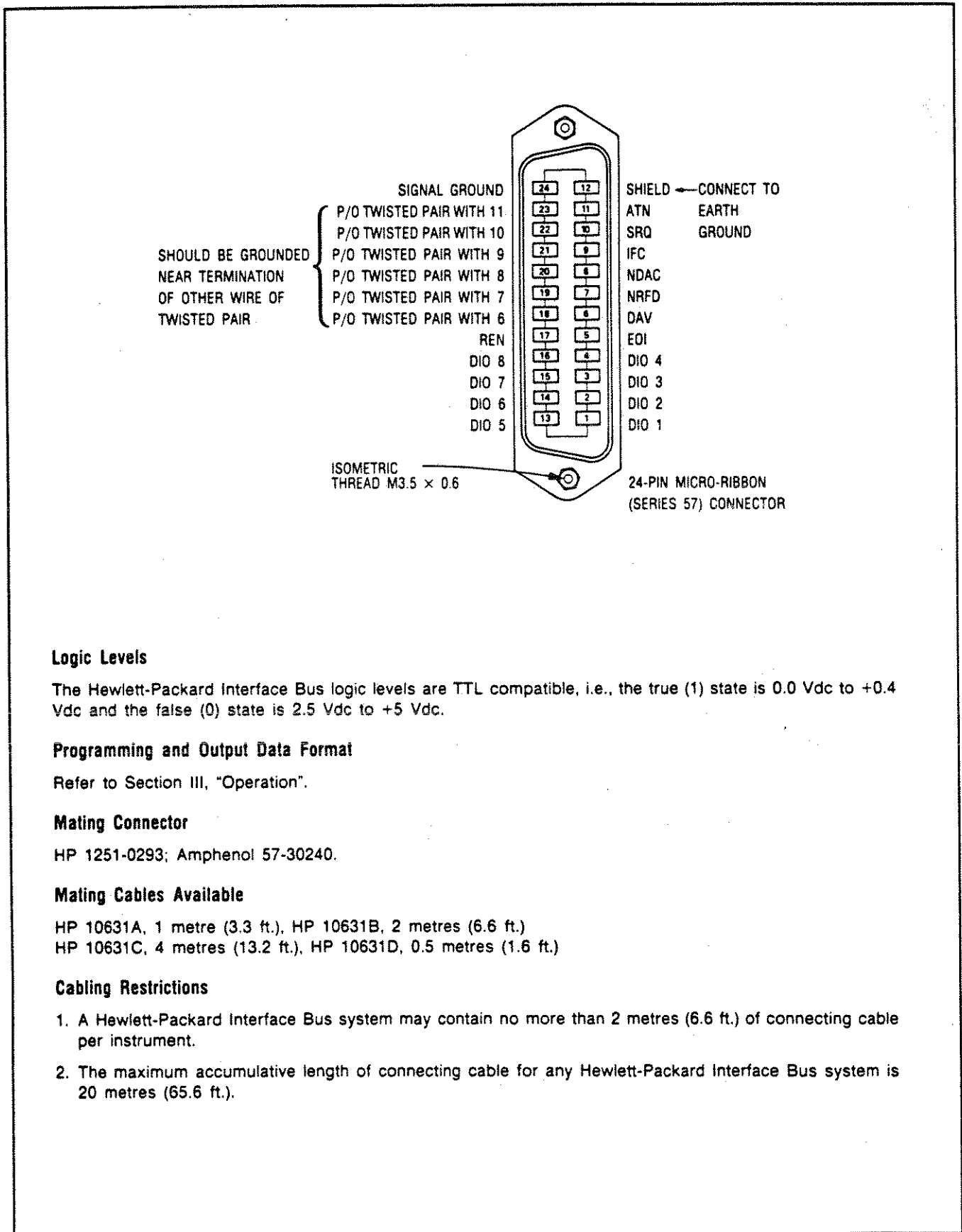

Logic Levels

The Hewlett-Packard Interface Bus logic levels are TTL compatible, i.e., the true (1) state is 0.0 Vdc to +0.4 Vdc and the false (0) state is 2.5 Vdc to +5 Vdc.

Programming and Output Data Format

Refer to Section III, "Operation".

Mating Connector

HP 1251-0293; Amphenol 57-30240.

Mating Cables Available

HP 10631A, 1 metre (3.3 ft.), HP 10631B, 2 metres (6.6 ft.)
 HP 10631C, 4 metres (13.2 ft.), HP 10631D, 0.5 metres (1.6 ft.)

Cabling Restrictions

1. A Hewlett-Packard Interface Bus system may contain no more than 2 metres (6.6 ft.) of connecting cable per instrument.
2. The maximum accumulative length of connecting cable for any Hewlett-Packard Interface Bus system is 20 metres (65.6 ft.).

Figure 3-2. Hewlett-Packard Interface Bus Connection

EXAMPLE 2. Set 107.654321 MHz Center

Input (0=High, 1=Low)	Temporary Register	CF Register
Data: D ₁ 0001 (1) D ₂ 0010(2)	00 00 00 00 00	Last Input
Temporary Command	21 00 00 00 00	Last Input
Data: D ₁ 0011 (3) D ₂ 0100(4)	21 00 00 00 00	Last Input
Temporary Command	43 21 00 00 00	Last Input
Data: D ₁ 0101 (5) D ₂ 0110(6)	43 21 00 00 00	Last Input
Temporary Command	65 43 21 00 00	Last Input
Data: D ₁ 0111 (7) D ₂ 0000(0)	65 43 21 00 00	Last Input
Temporary Command	07 65 43 21 00	Last Input
Data: D ₁ 1111 (15) D ₂ 0000(0)	01 07 65 43 21	Last Input
Temporary Command	00 00 00 00 00	01 07 65 43 21

EXAMPLE 3. Set 120 dB Attenuation (RF SECTION) Below +13 dBm (1 volt)

Input (0=High, 1=Low)	Temporary Register	CF Register
Data: D ₁ 0010 (2) D ₂ 0001(1)	00 00 00 00 00	Last Input
Temporary Command	12 00 00 00 00	Last Input
Address: D ₁ 1111 (15) D ₂ 0011(3)	12 00 00 00 00	Last Input
Transfer Command	00 00 00 00 00	120

NOTE: The attenuator is a three-digit register; only the three most significant digits are retained.

EXAMPLE 4. Set 7 dB Attenuation (RF SECTION) Below +13 dBm (1 volt)

Input (0=High, 1=Low)	Temporary Register	CF Register
Data: D ₁ 0000 (0) D ₂ 0111(7)	00 00 00 00 00	Last Input
Temporary Command	70 00 00 00 00	Last Input
Data: D ₁ 0000 (0) D ₂ 0000(0)	70 00 00 00 00	Last Input
Temporary Command	00 70 00 00 00	Last Input
Address: D ₁ 1111 (15) D ₂ 0011(3)	00 70 00 00 00	Last Input
Transfer Command	00 00 00 00 00	007

NOTE: The attenuator is a three-digit register; only the three most significant digits are retained.

EXAMPLE 5. Shut off Modulation (MODULATION SECTION)

Input (0=High, 1=Low)	Temporary Register	CF Register
Address: D ₁ 1111 (15) D ₂ 0100(4)	00 00 00 00 00	Last Input
Transfer Command	00 00 00 00 00	000
NOTE: All digits are zero - no modulation.		

EXAMPLE 6. Set 3% AM Modulation, Internal 1 kHz (MODULATION SECTION)

Input (0=High, 1=Low)	Temporary Register	CF Register
Data: D ₁ 0011 (3) D ₂ 0000(0)	00 00 00 00 00	Last Input
Temporary Command	03 00 00 00 00	Last Input
Address: D ₁ 1111 (15) D ₂ 0101(5)	03 00 00 00 00	Last Input
Transfer Command	00 00 00 00 00	03 into % Storage
Data: D ₁ 0001 (2) D ₂ 1000(8)	00 00 00 00 00	
Temporary Command	81 00 00 00 00	
Address: D ₁ 1111 (15) D ₂ 0100(4)	81 00 00 00 00	
Transfer Command	00 00 00 00 00	81 into AM-FM Function Register Sets AM and 1 kHz
NOTE: See Table 3-5 for AM-FM Function Register Codes		

EXAMPLE 7. Set 10 MHz STEP ↑

Input (0=High, 1=Low)	Temporary Register	CF Register
Data: D ₁ 0000 (0) D ₂ 0001(1)	00 00 00 00 00	Last Input
Temporary Command	10 00 00 00 00	Last Input
Data: D ₁ 0000 (0) D ₂ 0000(0)	10 00 00 00 00	Last Input
Temporary Command	00 10 00 00 00	Last Input
Address: D ₁ 1111 (15) D ₂ 0001(1)	00 10 00 00 00	Last Input
Transfer Command	00 00 00 00 00	00 10 00 00

Table 3-5. AM-FM Function Register Coding

Function	Digit 2 (D ₂) (0=High, 1=Low)	Function	Digit 1 (D ₁) (0=High, 1=Low)
ΦM	1100 (12)	EXT. AC (Unleveled)	1001 (9) (HP 86633 only)
FM × 0.1	0100 (4)	EXT. DC	0100 (4)
FM × 1	0010 (2)	INT. 400 Hz	0010 (2)
FM × 1)	0001 (1)	INT. 1 kHz	0001 (1)
OFF	0000 (0)		

Table 3-6. Programming Connections to A23J3 (Remote Inputs - Rear Panel).

From A23J3	To A3XA5	Signal	Other
Pin 1			To A23J3 Pin 18
Pin 3	Pin 2	Error	
Pin 5	Pin 5	LCL-RMT	
Pin 9	Pin 11	Command	
Pin 13	Pin 15	Digit 1-8	
Pin 14	Pin 16	Digit 1-4	
Pin 15	Pin 17	Digit 1-2	
Pin 16	Pin 18	Digit 1-1	
Pin 17	Pin A	Flag (Busy)	
Pin 24	Pin J	Reset	
Pin 28	Pin S	Digit 2-8	
Pin 29	Pin T	Digit 2-4	
Pin 30	Pin U	Digit 2-2	
Pin 31	Pin V	Digit 2-1	
Pin 36			To Ground

A23J3 pins not listed are also wired to A3XA5. See the Rear Interface Assembly schematic diagram for wiring information.

Section 4

PERFORMANCE TESTS

4-1. INTRODUCTION

Most of the procedures in this section apply to verifying the instrument's electrical performance using the specifications of table 1-1 as the performance standards. Performance Test 3, Phase Locked Loops Test, verifies that the error voltage for each phase locked loop is within normal operating limits, but does not verify any instrument specifications.

The Operator's Checks in section 3 are useful for incoming inspections, routine maintenance, and general post-repair checks.

Other instrument performance specifications depend on the modulation and RF plug-in section installed. The service manual for the associated plug-in sections provide performance tests specific to the plug-in.

4-2. EQUIPMENT REQUIRED

Equipment required for the performance tests is listed in the Recommended Test Equipment table in Section 1. Any equipment that satisfies the critical specifications given in the table may be substituted for the recommended model(s).

4-3. TEST RECORD

Results of the performance tests may be tabulated in the Performance Test Record, Table 4-1. It is located on the last page of this section, we suggest that you make several copies of the table for future use before the you perform the first performance test. Test results recorded at incoming inspection can then be used for comparison in periodic maintenance and troubleshooting and after repairs or adjustments.

Performance Test 1

INTERNAL CRYSTAL OSCILLATOR AGING RATE

Specifications

Reference Oscillator Internal: 10 MHz quartz oscillator. Aging rate less than $(\pm 3 \text{ parts in } 10^{-9})$ per 24 hours after 30 day warmup.

Description

This test verifies the reference oscillator aging rate after the instrument has been connected to the ac line for 72 hours.

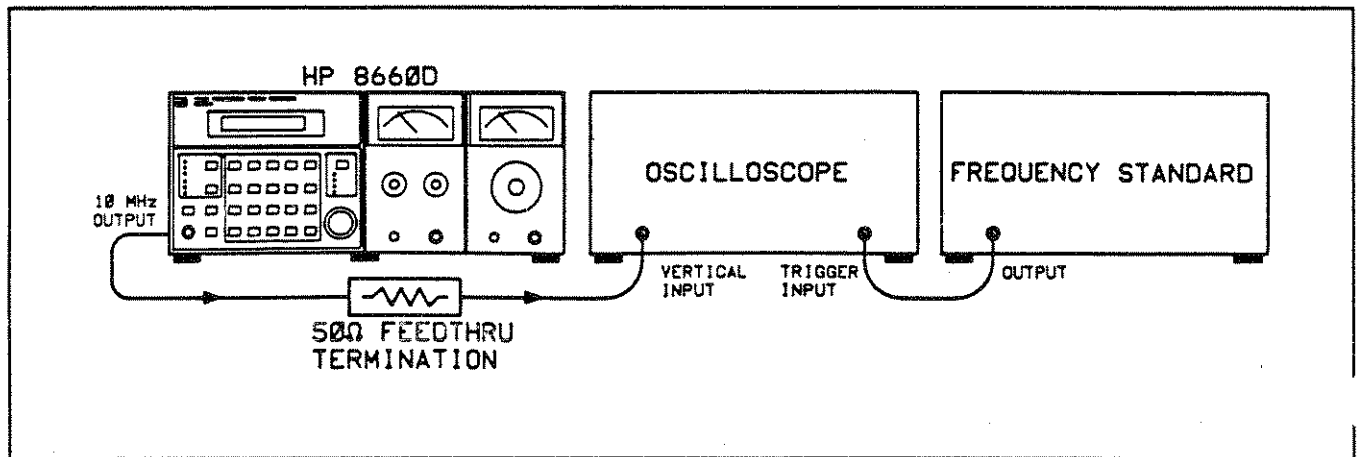

Figure 4-1. Crystal Oscillator Aging Rate Test Setup

Equipment

Frequency Standard	HP 5065A
Oscilloscope	HP 54200A
50Ω Feedthru Termination	HP 10100C

Procedure

1. Set the rear panel REFERENCE switch to INT.
2. Connect the equipment as shown in Figure 4-1.
3. Adjust the oscilloscope controls for a stable display of the 10 MHz output.
4. Measure the time required for a phase change of 360°. Record the time (T_1) in seconds.

$T_1 = \underline{\hspace{2cm}} \text{ s}$

5. Wait for a period of time (from 3 to 24 hours) and re-measure the phase change time (T_2). Record the period of time between measurements (T_3) in hours.

$$T_2 = \text{_____} \text{ s}$$

$$T_3 = \text{_____} \text{ h}$$

6. Calculate the aging rate from the following equation:

$$\text{Aging Rate} = \left| \left(\frac{1 \text{ cycle}}{f} \right) \left(\frac{1}{T_1} - \frac{1}{T_2} \right) \left(\frac{T}{T_3} \right) \right|$$

where:

- 1 cycle = the phase change reference for the time measurement (in this case 360°)
 f = Synthesizer's reference output frequency (10 MHz)
 T = specified time for aging rate (24 hours)
 T_1 = initial time measurement(s) for a 360° (1 cycle) change
 T_2 = final time measurement(s) for a 360° (1 cycle) change
 T_3 = time between measurement(s) (hours)

for example if:

- T_1 = 351 seconds
 T_2 = 349 seconds
 T_3 = 3 hours

then:

$$\text{Aging Rate} = \left| \left(\frac{1 \text{ cycle}}{10 \text{ MHz}} \right) \left(\frac{1}{351 \text{ s}} - \frac{1}{349 \text{ s}} \right) \left(\frac{24 \text{ hrs}}{3 \text{ hrs}} \right) \right| = 1.306 \times 10^{-11}$$

7. Enter calculated Aging Rate in Table 4-1.

Performance Test 2

REFERENCE TEST

Specifications

At 5 or 10 MHz from 0.75 to 1.5 Vrms into 170 ohms.

Description

This test verifies proper operation of the reference amplifier and relay switching circuits.

Equipment

RF Voltmeter HP 3400A

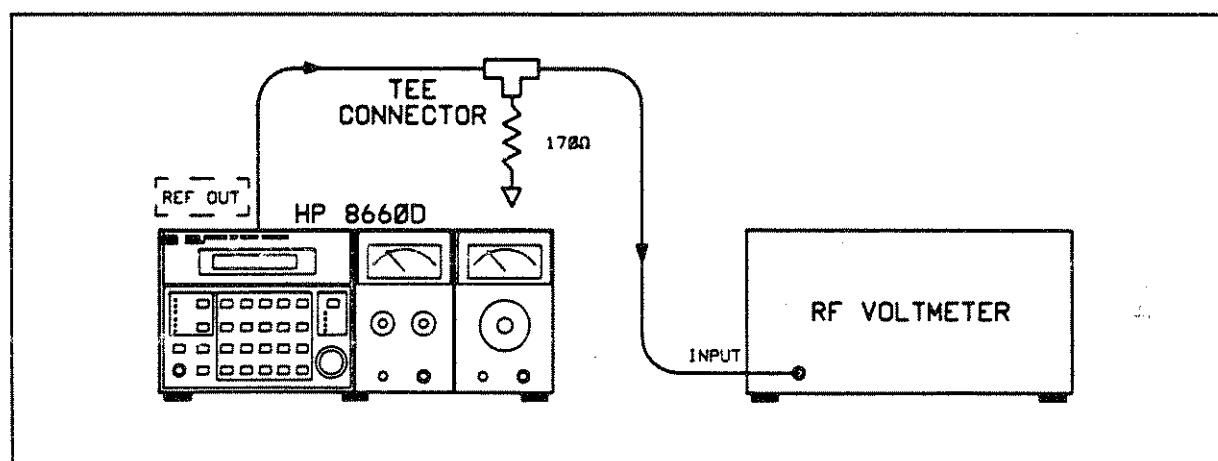

Figure 4-2. Internal Reference Test Setup

Procedure

1. Connect the RMS Voltmeter to the REFERENCE OUTPUT (rear panel) jack and set the SELECTOR switch (rear panel) to the INT position.
2. The RF Voltmeter should display a voltage from 0.75 to 1.5 Vrms.
3. Enter measured voltage in Table 4-1.

Performance Test 3

PHASE LOCKED LOOPS TEST

Specifications

N1, N2, N3, SL1, and SL2 Loop error voltages must be $0V \pm 500 \text{ mVdc}$. HF Loop error voltage must be $0V \pm 100 \text{ mVdc}$.

Description

The Phase Locked Loops Test does not verify any instrument specifications. The purpose of this test is to determine if the error voltages for the phase locked loops require adjustment.

If the loops do not meet the limits of this test, then perform the abbreviated adjustment procedure (adjustment 1) for the Phase Locked Loops. The HP 8660D will function correctly with associated RF and modulation sections when the error voltages are within these limits. It is recommended that the abbreviated adjustment procedure be performed regularly (every six months) to insure trouble-free performance of the HP 8660D.

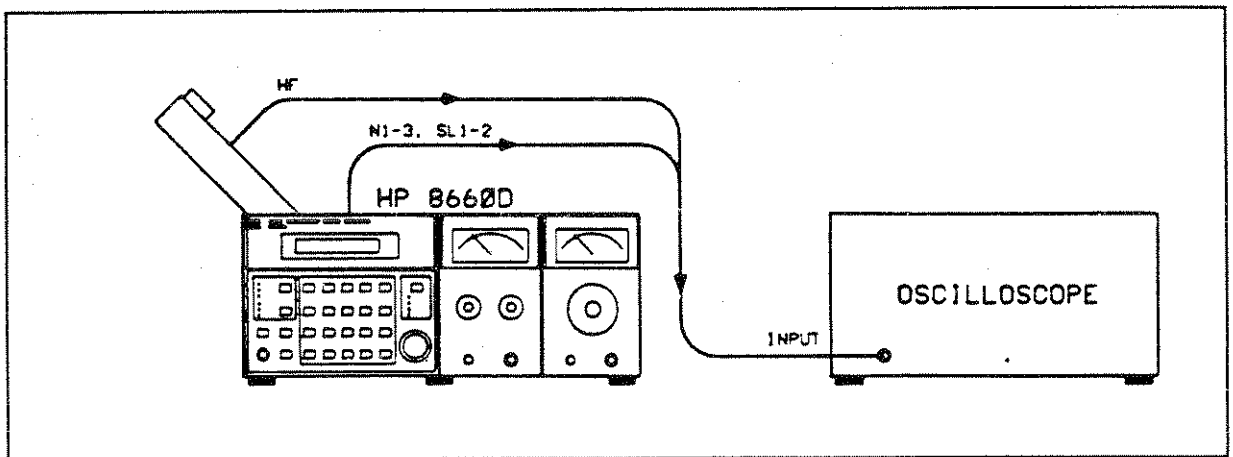

Figure 4-3. Phase Locked Loop Test Setup

Equipment

Oscilloscope (with 10:1 divider probes) HP 54200A

Procedure

NOTE

Set the HP 8660D Line switch to ON and allow the instrument to warm up with the covers on for at least six hours before starting the measurements. The warm-up period is required to stabilize the internal temperature.

1. Set up the test equipment as shown in Figure 4-3.
2. Adjust the oscilloscope as follows:

VOLTS/DIV	0.01V
TIME/DIV	10 μ s
MODE	DC COUPLED
GROUND POSITION	CENTER OF DISPLAY

NOTE

All of the test points except for the HF loop are located on the Low Frequency motherboard. Access to these test points is obtained by raising the A4 assembly and locking it in the up position (see Figure 4-3). Figure 5-23 shows the approximate location of all test points. The reference designators of the test points are etched on the pc board. Access to TP3 and TP8 is difficult because they are under the A3A1 and A3A2 assemblies. TP3 can be reached by using a piece of solid wire to probe down into the test point. TP8 is connected to XA12-1 pin 4, which is accessible.

3. Connect the oscilloscope probe to TP 17, the first test point specified in Table 4-1, N1 Loop. Set the HP 8660D CF to the corresponding frequency values, and record the measured DC offsets. If the DC offset exceeds $0.0V \pm 500mV$, perform Adjustment 1 (abbreviated phase locked loops adjustment procedure). Repeat this procedure for all 6 loops in Table 4-1. Note that the HF Loop DC offset should not exceed $0.0V \pm 100 mV$ after thermal stability is reached. Typically, the HP 8660D will be thermally stable after six hours of warm-up with the covers on.

NOTE

The trace displayed on the oscilloscope should be a dc level. It is normal for some ac components to appear on the trace. However, if the peak-to-peak amplitude of the ac component is greater than 500 mV, the loop is probably not locked. Also, if the trace cannot be adjusted to 0 volts, the loop is probably not locked. In either case, the full adjustment procedure should be performed.

Table 4-1. Performance Test Record (1 of 2)

Hewlett-Packard Model 8660D Synthesized Signal Generator Serial No. _____		Tests Performed by _____ Date _____			
Crystal Oscillator Aging Rate:		Standard $< 3 \times 10^{-9}$		Actual _____	
Output Reference Level:		Minimum 0.75 Vrms	Maximum 1.5 Vrms	Actual _____	
Phase Locked Loops:					
N1 Loop		N2 Loop		N3 Loop	
CF (MHz)	Vdc @ TP17 ⁽¹⁾	CF (kHz)	Vdc @ TP10 ⁽¹⁾	CF (Hz)	Vdc @ TP3 ⁽¹⁾
0	_____	0	_____	0	_____
1.1	_____	11.1	_____	11	_____
2.2	_____	22.2	_____	22	_____
3.3	_____	33.3	_____	33	_____
4.4	_____	44.4	_____	44	_____
5.5	_____	55.5	_____	55	_____
6.6	_____	66.6	_____	66	_____
7.7	_____	77.7	_____	77	_____
8.8	_____	88.8	_____	88	_____
9.9	_____	99.9	_____	99	_____
SL2 Loop		SL1 Loop		HF Loop	
CF (kHz)	Vdc @ TP8 ⁽¹⁾	CF (MHz)	Vdc @ TP14 ⁽¹⁾	CF (MHz)	Vdc @ PHASE ERROR ⁽²⁾
94.5	_____	9.45	_____	0	_____
84.5	_____	8.45	_____	10	_____
74.5	_____	7.45	_____	20	_____
64.5	_____	6.45	_____	30	_____
54.5	_____	5.45	_____	40	_____
44.5	_____	4.45	_____	50	_____
34.5	_____	3.45	_____	60	_____
24.5	_____	2.45	_____	70	_____
14.5	_____	1.45	_____	80	_____
4.5	_____	0.45	_____	90	_____
(1) ± 500 mVdc. (2) ± 100 mVdc.					

Table 4-1. Performance Test Record (2 of 2)

Hewlett-Packard Model 8660D Synthesized Signal Generator		Tests Performed by _____			
Serial No. _____		Date _____			
Crystal Oscillator Aging Rate:		Standard $< 3 \times 10^{-9}$		Actual _____	
Output Reference Level:		Minimum 0.75 Vrms		Maximum 1.5 Vrms	
Phase Locked Loops:					
N1 Loop		N2 Loop		N3 Loop	
CF (MHz)	Vdc @ TP17⁽¹⁾	CF (kHz)	Vdc @ TP10⁽¹⁾	CF (Hz)	Vdc @ TP3⁽¹⁾
0	_____	0	_____	0	_____
1.1	_____	11.1	_____	11	_____
2.2	_____	22.2	_____	22	_____
3.3	_____	33.3	_____	33	_____
4.4	_____	44.4	_____	44	_____
5.5	_____	55.5	_____	55	_____
6.6	_____	66.6	_____	66	_____
7.7	_____	77.7	_____	77	_____
8.8	_____	88.8	_____	88	_____
9.9	_____	99.9	_____	99	_____
SL2 Loop		SL1 Loop		HF Loop	
CF (kHz)	Vdc @ TP8⁽¹⁾	CF (MHz)	Vdc @ TP14⁽¹⁾	CF (MHz)	Vdc @ PHASE ERROR⁽²⁾
94.5	_____	9.45	_____	0	_____
84.5	_____	8.45	_____	10	_____
74.5	_____	7.45	_____	20	_____
64.5	_____	6.45	_____	30	_____
54.5	_____	5.45	_____	40	_____
44.5	_____	4.45	_____	50	_____
34.5	_____	3.45	_____	60	_____
24.5	_____	2.45	_____	70	_____
14.5	_____	1.45	_____	80	_____
4.5	_____	0.45	_____	90	_____
(1) ± 500 mVdc. (2) ± 100 mVdc.					

Section 5 ADJUSTMENTS

5-1. INTRODUCTION

This section describes adjustments and checks required to return the HP 8660D to peak operating capability when periodic adjustments are required or when repairs have been made. Included in this section are test setups and procedures.

Except for the Abbreviated Phase Locked Loops and Power Supply adjustment procedures, which should be performed before repairs are made to any part of the instrument, the adjustment procedures are arranged in the same sequence as the service sheets to which they refer.

5-2. PERIODIC ADJUSTMENTS REQUIRED

The following table shows adjustments that should be performed at recommended 6 month, but no longer than 1 year, intervals.

Table 5-1. Periodic Adjustments

Adjustment	Steps
Adjustment 1: Phase Locked Loops (Abbreviated)	All
Adjustment 2: Power Supply	All
Adjustment 3: Reference Section (100 MHz Output)	2

All other adjustments need only be performed after repair, or to correct instrument malfunction.

5-3. EQUIPMENT REQUIRED

Each adjustment procedure in this section contains a list of test equipment and accessories required to perform the procedure. Each test setup identifies test equipment and accessories by callouts.

Minimum specifications for test equipment used in the adjustment procedures are detailed in Table 1-2. Because the HP 8660D Synthesized Signal Generator is an extremely accurate instrument, minimum specifications in Table 1-2 are particularly important in performing these adjustment procedures.

5-4. ADJUSTMENT AIDS

The HP 11672A Service Kit is an accessory item available from Hewlett-Packard for use in maintaining the HP 8660D. Table 1-2 contains a detailed description of the Service Kit. Any item in the kit may be ordered separately.

5-5. FACTORY SELECTED COMPONENTS

Some component values are selected at the time of final checkout at the factory. Usually these values are not extremely critical; they are selected to provide optimum compatibility with associated components.

Factory selected components and suggested range of values are listed in Table 5-2.

The recommended procedure for replacing a factory selected component is as follows:

- a. Try the original value, then perform the test specified in Section V of this manual for the circuit being repaired.
- b. If the specified test cannot be satisfactorily performed, try the typical value shown in the parts list and repeat the test.
- c. If the test results are still not satisfactory, substitute various values within the tolerances specified in Table 5-2 until the desired result is achieved.

5-6. RELATED ADJUSTMENTS

Most of the adjustments within any given phase lock loop are interrelated. This is especially true in digital-to-analog converters. Adjustments should be made in the order in which they appear for any given loop.

Generally, it will not be necessary to adjust any of the phase lock loops except the one in which the component failure occurred. An exception to this will be when adjustment to any phase lock loop has been attempted while the reference section is not functioning properly.

5-7. ADJUSTMENT LOCATIONS

Adjustment locations are identified pictorially on Section VIII foldout service sheets referred to in the individual procedures and in Figures listed in the individual procedures.

5-8. CHECKS AND ADJUSTMENTS

Data taken while following the adjustment procedures should be recorded in spaces provided. This information may then be used as reference in later tests.

5-9. SAFETY CONSIDERATIONS

Although this instrument has been designed in accordance with international safety standards, this manual contains information and warnings, which must be followed to ensure safe operation and to retain the instrument in a safe condition (see Section II). Service and adjustments should be performed only by qualified service personnel.

WARNING

Any interruption of the protective (grounding) conductor inside or outside the instrument or disconnection of the protective earth terminal is likely to make the apparatus dangerous. Intentional interruption is prohibited.

Any adjustment, maintenance, and repair of the opened instrument under voltage should be avoided as much as possible and, when inevitable, should be carried out only by a skilled person who is aware of the hazards involved. The opening of covers or removal of parts may expose live parts, and accessible terminals may be live.

Capacitors inside the instrument may still be charged even if the instrument has been disconnected from its source of supply.

Make sure that only fuses with the required rated current and of the specified type (normal blow, time delay, etc.) are used for replacement. The use of repaired fuses and the short-circuiting of fuseholders must be avoided.

Whenever it is likely that the protection has been impaired, the instrument must be made inoperative and be secured against any unintended operation.

NOTE

When repairs or adjustments to the instrument are required, such work should not be performed, even by a skilled technician, unless another person is in the same general area. This is not to be interpreted to mean that two persons are required to perform the necessary work, but only that another person should be available, should the need for assistance arise.

In Adjustments 1-12 it is assumed that:

- a. At the start of the test the output frequency is set to 0.
- b. An RF Section output plug-in section must be in place during the tests.
- c. A Modulator Section or an Auxiliary Section must be in place in the modulator compartment.
- d. All tests in which a counter is used should be made with the HP 8660D and the counter referenced to the same source. The HP 8660D internal reference may be used as the source.

Table 5-2. Factory Selected Components (1 of 2)

Designation	Location	Purpose	Range of Values
A4A2C11	Reference Loop	A variable 10 MHz signal (at -45 dB) is connected in parallel with the 10 MHz reference signal to A4J5. The frequency is varied to show the 3 dB points. The capacitor is selected for the reference loop 3 dB bandwidth of 60 to 160 kHz (± 30 to ± 80 kHz) measured at the 100 MHz output.	38 to 72 pF
A4A2R42	Phase Detector	To achieve correct phase error signal level.	100 to 422 ohms
A4A4C10	Reference VCO	To set reference loop bandwidth and capture range. Interacts with A4A2C11.	10 to 56 pF
A4A4L12	Reference Loop	To control output level of 100 MHz	0.34 to 1.0 μ H
A4A4Q7	Reference Loop	To optimize performance of 500 MHz tuned amplifier	
A4A4Q8	Reference Loop	To optimize performance of 100 MHz tuned amplifier	
A4A4R29	Reference VCO and Divider	To compensate for variations in the 100 MHz reference output level. Selected for an output level of +11 to +13 dBm into a 50 ohm load at the output of A4A8.	42.2 to 422 ohms

Table 5-2. Factory Selected Components (2 of 2)

Designation	Location	Purpose	Range of Values
A4A5C7,C8, C13, C14, C19, C20	HF Loop VCO	If one or more of the amplifiers in the 340 to 450 MHz tuned amplifier stages are overdriven, a one half frequency harmonic spur will track the output signal. Reduce the drive to the overdriven stage by decreasing the value of the appropriate capacitor. After selecting a capacitor, be sure there is sufficient output to drive the amplifier.	7.5 to 24 pF
A4A5R38, 40, and 42 (50 ohm pad)	HF VCO	To compensate for variations in the 350/450 MHz output level. Selected for a level of +10 to +13 dBm.	See Table 5-3.
A4A5R37, 39, and 41 (50 ohm pad)	HF Loop	To compensate for variations in the 350/450 MHz output level to the phase detector. Selected for a level of +10 to +12 dBm.	See Table 5-3.
A4A6C6	HF Loop	To ensure tuning range sufficient to trap the 10 MHz signal.	16 to 24 pF
A4A6R19	HF Loop	To center the travel of A4A6R20 Profile Adjust	215 to 422 ohms
A4A7R23	Sampling Phase Detector	To permit adjustment of A4A7R22. See paragraph 5-30 step 2b.	7.5k to 11k
A8R18	N3 Oscillator	To aid in balancing Summing loop for Varactor tuning	19.6k to 25k
A8R25	N3 Oscillator		4k to 6k
A13R30	N2 VCO	To center range of associated potentiometer.	5.62k to 8.25k
A13R36	N2 VCO	To center range of associated potentiometer.	12.1k to 17.4k
A13R60	N2 VCO	To compensate for variations in the Varactor diode by reducing phase error output of the N2 assembly. Selected for an output at A2TP10 phase monitor of 0.00 ± 0.35 Vdc	68k to 120k
A13R81	N2 VCO	To produce the most symmetrical square wave at A14aTP1. See Service Sheet 9A and 10.	23.7 to 237 ohms
A16R2	N1 Phase Detector	To compensate for variations in U7A switching characteristics.	825 ohms to 1.21k
A17R29	N1 VCO	To center range of associated potentiometer.	12.1k to 17.4k
A17R32	N1 VCO	To center range of associated potentiometer.	5.11k to 7.5k
A19R55	SL1 Oscillator	To set the SL1 Oscillator output between -3 & -5 dBm.	511 ohms to 1.47k

Table 5-3. Range of Values

Resistor	2 dB	3 dB	4 dB	5 dB	6 dB	7 dB	8 dB
R37,R38,(R41,R42)	422	287	315	178	147	133	115
R39(R40)	12.1	17.8	23.7	28.7	34.8	46.4	51.1

Adjustment 1

PHASE LOCKED LOOPS (ABBREVIATED)

Description

This procedure specifies the adjustments for the phase locked loops which are most likely to change due to aging or temperature effects and thus require periodic attention. This procedure can only be used if a phase locked loop is locked. If it is not, the full adjustment procedure should be performed.

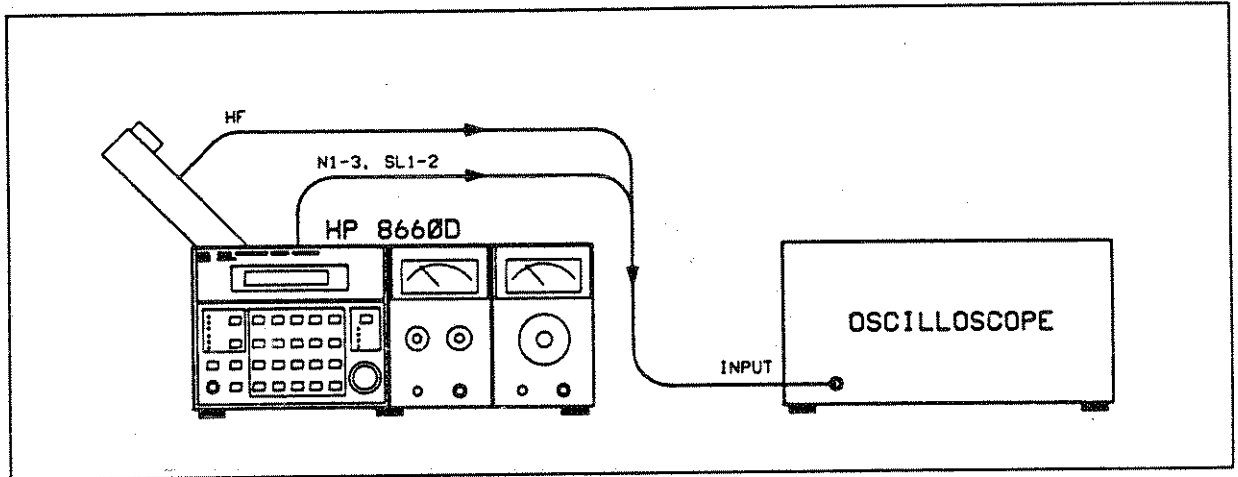

Figure 5-1. Abbreviated Phase Locked Loops Test Setup

Test Equipment

Oscilloscope (with 10:1 divider probes) HP 54200A

Procedure

NOTE

Set the HP 8660D Line switch to ON and allow the instrument to warm up with the covers on for at least six hours before starting the measurements. The warm-up period is required to stabilize the internal temperature.

1. Set up the test equipment as shown in Figure 5-1.
2. Adjust the oscilloscope as follows:

VOLTS/DIV	0.01V (Actually 0.1V since 10:1 probes are used)
TIME/DIV	10 μ s
MODE	DC COUPLED
GROUND POSITION	CENTER OF DISPLAY

NOTE

All of the test points except for the HF loop are located on the A2 Motherboard. Access to these test points is obtained by raising the A4 assembly and locking it in the up position (see Figure 5-1). Figure 5-23 shows the approximate location of all test points. The reference designators of the test points are etched on the pc board. Access to TP3 and TP8 is difficult because they are under the A3A1 and A3A2 assemblies. TP3 can be reached by using a piece of solid wire to probe down into the test point. TP8 is connected to XA12-1 pin 4, which is accessible.

- In Table 5-4, PLL Adjustment Points, connect the oscilloscope probe to the test point corresponding to the loop being adjusted (start with N1 Loop TP 17). Set the HP 8660D CF to the frequency value under the Adjustment 1 column, then the Adjustment 2 column, adjusting the corresponding potentiometer for $0V \pm 50$ mVdc. Adjustments 1 and 2 are interactive. Repeat the adjustments until both measurements are correct.

NOTE

The trace displayed on the oscilloscope should be a dc level. It is normal for some ac components to appear on the trace. However, if the peak-to-peak amplitude of the ac component is greater than 200 mV, the loop is probably not locked. Also, if the trace cannot be adjusted to the required level, the loop is probably not locked. In either case, the full adjustment procedure should be performed.

Table 5-4. PLL Adjustment Points

Loop	Test Point	Adjustment 1		Adjustment 2	
		CF	Adj Point	CF	Adj Point
N1	TP17	9.5MHz	A17R31	0.5 MHz	A17R28
N2	TP10	95.5 MHz	A13R37	5.5 kHz	A13R39
N3	TP3	95Hz	A8R26	5 Hz	A8R24
SL2	TP8	94.5 kHz	A11R19	4.5 kHz	A11R15
SL1	TP14	9.45MHz	A19R9	0.45 MHz	A19R3
HF	PHASE ERROR	0 MHz	A4A6R20 "0"	90 MHz ⁽¹⁾	A4A6R20 PROFILE

⁽¹⁾ If an 86601A RF Section is installed, set CF to 100.0 MHz.

- If the N1, N2, or N3 loop is being adjusted, continue with Step 5. If the SL1, SL2, or HF loop is being adjusted, jump to step 7.
- Set the HP 8660D to the center frequencies in Table 5-5 for the loop that is being adjusted. At each frequency setting, record the voltage level displayed on the oscilloscope. Ensure that the loop remains locked at each of these settings.

6. When all voltages have been recorded for the loop being adjusted, do the following:

Add all voltage readings and enter as the SUM value.

Divide the Sum value by 10 and enter the average (AVG).

Reverse the sign (polarity) of the AVG value and enter this figure as the Adjust value.

Once again set the HP 8660D CF to the corresponding frequency value under the Adjustment 1 of Table 5-4 column for the loop being adjusted, and adjust the potentiometer in the Adj Point column to make the dc value of the oscilloscope trace equal to the calculated Adjust Value in Table 5-5.

Return to Step 3 and repeat the procedures until the N1, N2, and N3 loops are adjusted.

7. In Table 5-5 locate the HP 8660D frequency values given for the loop that is being adjusted (SL2, SL1, or HF Loops). At each frequency setting adjust the potentiometer under the Adjustment 1 column for a level of $0V \pm 100mVdc$ on the oscilloscope.
8. Return to Step 3 and repeat the procedures until the SL2, SL1, and HF Loops are adjusted.

Table 5-5. PLL Adjustment Values

N1 Loop		N2 Loop		N3 Loop	
CF (MHz)	Vdc @ TP17 ⁽¹⁾	CF (kHz)	Vdc @ TP10 ⁽¹⁾	CF (Hz)	Vdc @ TP3 ⁽¹⁾
0	-50mV	0	-100mV	0	
1.1	-30mV	11.1	-130mV	11	
2.2	80mV	22.2	-90mV	22	
3.3	70mV	33.3	-370mV	33	
4.4	170mV	44.4	-420mV	44	
5.5	110mV	55.5	-650mV	55	
6.6	130mV	66.6	-550mV	66	
7.7	50mV	77.7	-650mV	77	
8.8	90mV	88.8	-780mV	88	
9.9	-50mV	99.9	-950mV	99	
Sum	60mV	Sum		Sum	
Avg (Sum ÷ 10)		Avg (Sum ÷ 10)		Avg Sum (÷10)	
Adjust Value		Adjust Value		Adjust Value	
SL2 Loop		SL1 Loop		HF Loop	
CF (kHz)	Adj Point	CF (MHz)	Adj Point	CF (MHz)	Adj Point
84.5	A11R39 "8"	8.45	A18R35 "8"	10	A4A6R60 "1"
74.5	A11R54 "7"	7.45	A18R40 "7"	20	A4A6R56 "2"
64.5	A11R60 "6"	6.45	A18R44 "6"	30	A4A6R53 "3"
54.5	A11R67 "5"	5.45	A18R41 "5"	40	A4A6R58 "4"
44.5	A11R73 "4"	4.45	A18R55 "4"	50	A4A6R44 "5"
34.5	A11R77 "3"	3.45	A18R62 "3"	60	A4A6R40 "6"
24.5	A11R83 "2"	2.45	A18R67 "2"	70	A4A6R35 "7"
14.5	A11R90 "1"	1.45	A18R74 "1"	80	A4A6R28 "8"
				90	A4A6R22 "9"
				100 ⁽¹⁾	A4A6R22 "9"

(1) With 86601A only.

Adjustment 2

POWER SUPPLY

• Service Sheet 27

Description

The power supplies in the HP 8660D provide regulated outputs of +20V, +5.25V, -10V, and -40V. Unregulated supplies provide +30V, +21V, +4V and -21V. The following procedure should be used to adjust the regulated output of each power supply.

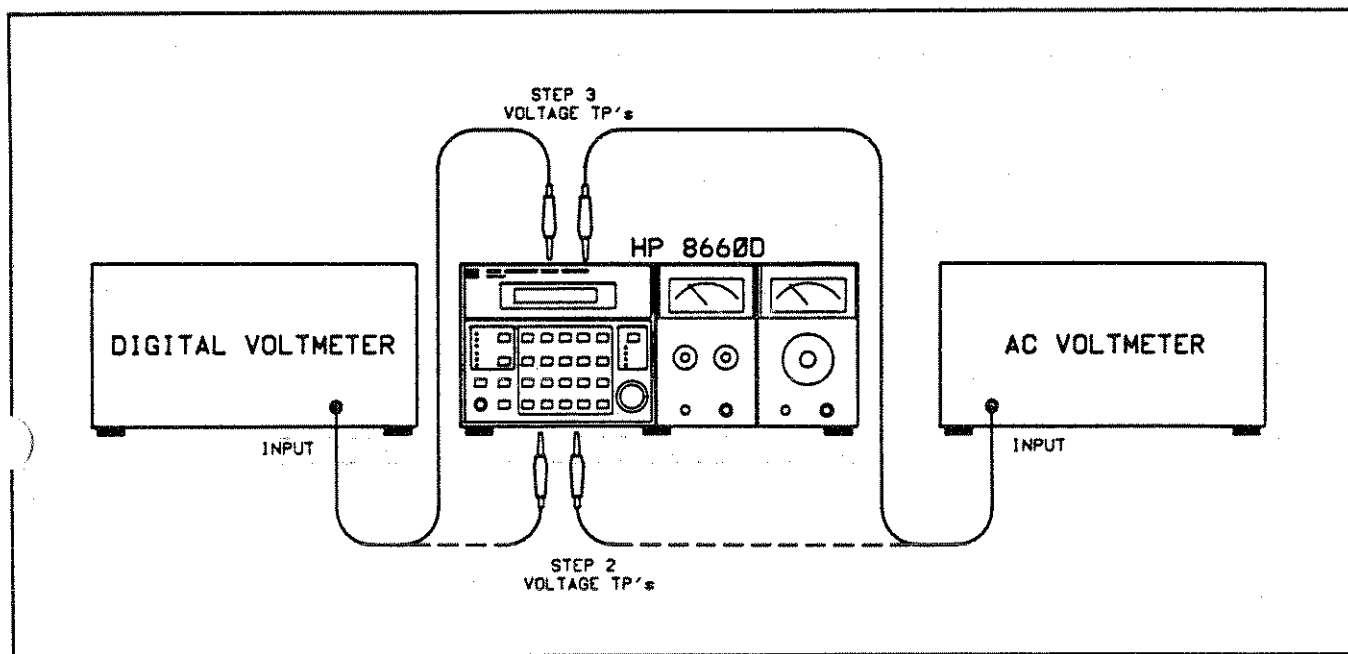

Figure 5-2. Power Supply Test Setup

Test Equipment

Digital Voltmeter	HP 3478A
AC Voltmeter	HP 3466A

Procedure

1. Set up test equipment as shown in Figure 5-2.
2. Remove the top and bottom covers of the HP 8660D.
3. Use the digital voltmeter and the ac microvoltmeter to check the voltages and ripple at A20 test points specified in Table 5-6.
4. Use the digital voltmeter to adjust each power supply voltage specified in Table 5-7 using the corresponding adjustment. Verify that the ripple does not exceed the limits indicated.

Table 5-6. Unregulated Power Supplies

Test Location	Voltage	Tolerance	Ripple (RMS)
+ side of A20C7	Typical +3.37V	Specified $\pm 0.6V$	Typical 0.31
+ side of A20C4	Typical +21V	Specified $\pm 2.4V$	Typical 1.1
- side of A20C5	Typical -21V	Specified $\pm 2.4V$	Typical 1.15
+ side of A20C1	Typical +33V	Specified $\pm 4V$	Typical 1.0

Table 5-7. Regulated Power Supplies

Test Point	Adjust Control	Voltage	Tolerance	Ripple (RMS)
A5TP4	A5R24 +5.25 ADJ	+5.25V	± 20 mV	125 μV
A5TP2	A5R26 -10 ADJ	-10.0V	± 5 mV	50 μV
A5TP3	A5R21 +20 ADJ	+20.0V	± 10 mV	50 μV
A5TP1	A5R28 -40 ADJ	-40.0V	± 20 mV	50 μV

Adjustment 3

REFERENCE SECTION

- Service Sheets 2 and 3.

Description

The reference section contains a voltage controlled master oscillator from which all RF signals generated in the HP 8660D mainframe are derived. The master oscillator is phase locked to an internal temperature controlled crystal oscillator or to an external standard. The reference section provides outputs of 500 MHz, 100 MHz, 20 MHz, 10 MHz, 2 MHz, 400 kHz and 100 kHz. These checks verify proper operation of the circuits within the reference section.

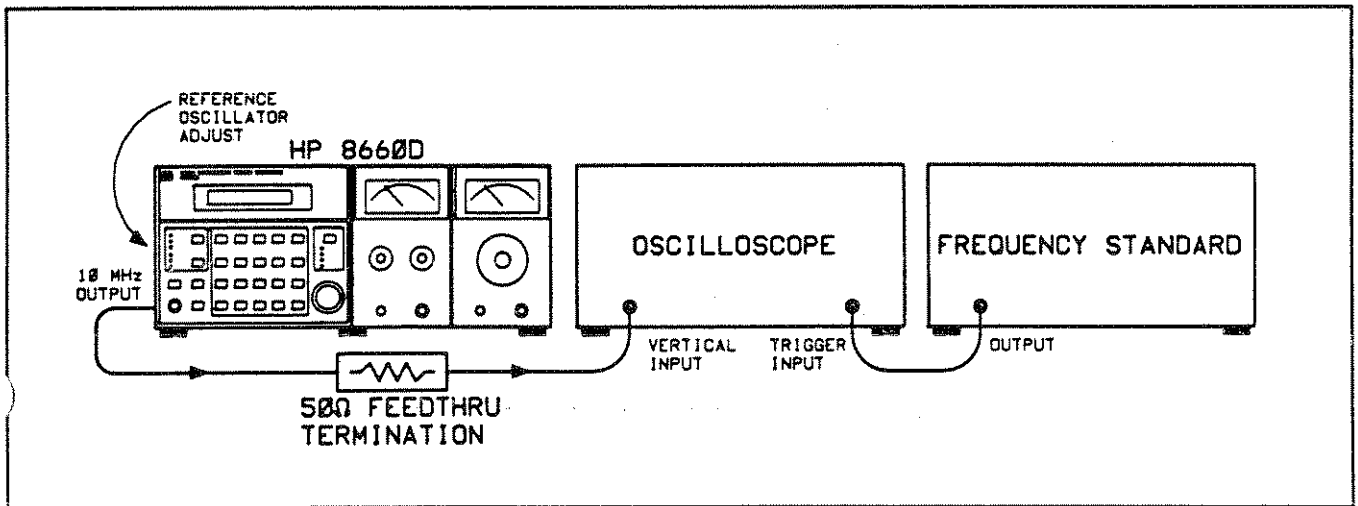

Figure 5-3. Reference Accuracy Adjustment Test Setup

Test Equipment

Frequency Standard	HP 5065A
Oscilloscope(with 10:1 divider probes)	HP 54200A
Spectrum Analyzer	HP 8590A
Frequency Counter	HP 5328B Option 031
50 Ohm Feedthru Termination	HP 10100C

Procedure

1. Set up test equipment as shown in Figure 5-3.
2. Internal Reference Accuracy Adjustment (see Figure 5-3). (Allow adequate warmup time.)
 - a. Use the signal source to trigger the oscilloscope at the SYNC INPUT and connect the reference output from the HP 8660D rear panel reference output to the oscilloscope vertical input.
 - b. Observe the 10 MHz sine wave on the oscilloscope and adjust the A21 oscillator until the oscilloscope display stops drifting.
 - c. Set the oscilloscope to sweep at 0.1 μ Sec/Division and the sweep magnifier to $\times 10$. If drift is observed readjust the A21 oscillator.

NOTE

When the oscilloscope display drift is less than 1 division in 10 seconds the HP 8660D reference oscillator is set within 1 part in 10⁹ of the signal source.

3. 100 MHz Output Adjustment.

- a. Connect the frequency counter to the 100 MHz output on the A4A4 assembly (see Figure 5-4).
- b. If the internal reference is being used, place the rear panel INT/EXT switch in the EXT position to open the 100 MHz phase lock loop. (If an external reference is being used, disconnect the source.)
- c. Allow at least 15 minutes warmup time for the oscillator to stabilize and adjust A4A4C2 for a counter readout of 100.000 MHz ± 20 kHz. Disconnect the frequency counter.
- d. Connect the Spectrum Analyzer RF INPUT to the 100 MHz output of the A4A4 assembly and tune the Spectrum Analyzer CENTER FREQUENCY to 100 MHz. The 100 MHz signal should be >+10 dBm (see Figure 5-5 and 5-6).
- e. Disconnect the Spectrum Analyzer and enable the 100 MHz phase lock loop by returning the INT/EXT switch to INT or by reconnecting the external standard.

NOTE

Steps f through p need to be performed only if the 100 MHz output signal is low or if the total harmonic distortion in the FM mode is > 1%.

- f. Use a standard flatblade screwdriver to loosen the fastener which locks the A4 assembly in place. Rotate A4 up and to the right until it locks into position.
- g. Disconnect W6 and A23W9 from the A4A8 100 MHz Band-pass Filter Assembly. Connect W6 to A23W9.
- h. Set the Synthesized Signal Generator controls for a center frequency of 100 MHz at +10 dBm.
- i. Set the spectrum analyzer controls as follows:

Center Frequency	100 MHz
Frequency Span Per Division	5 MHz
Resolution Bandwidth	100 kHz
Input Attenuation	20 dB
Vertical Sensitivity Per Division	10 dB
Reference Level	+10 dBm
Sweep Time Per Division	2 ms

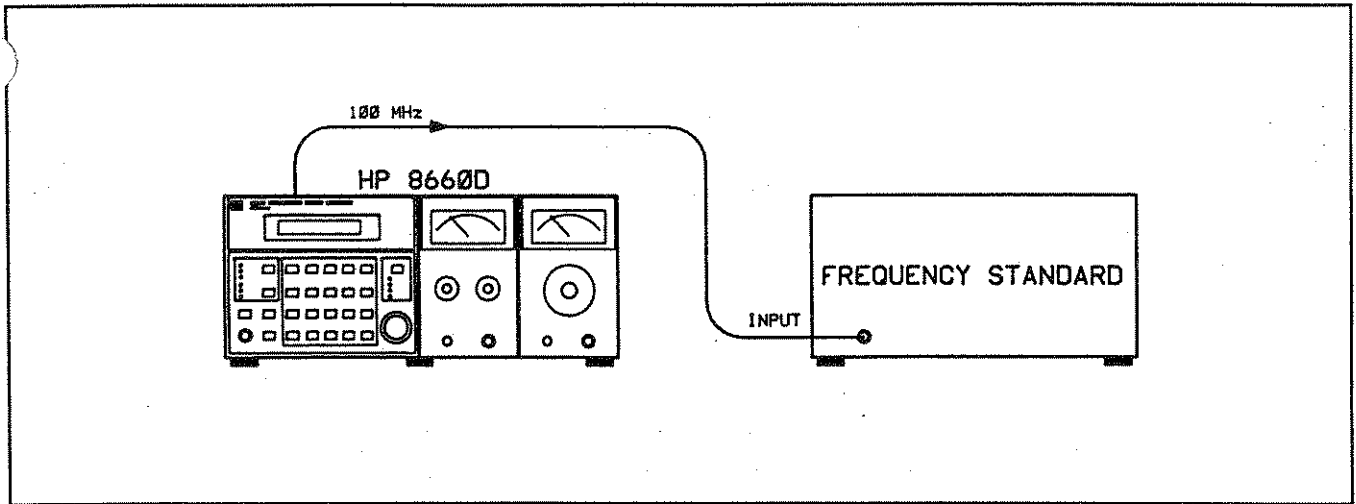

Figure 5-4. 100 MHz Adjustment Test Setup

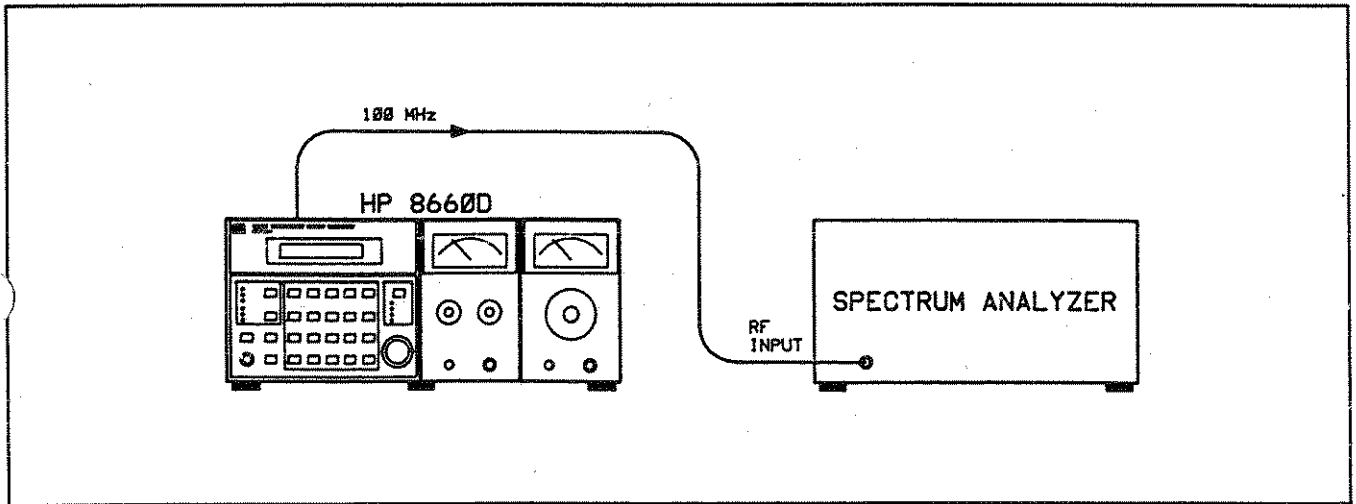

Figure 5-5. RF Level Checks Test Setup

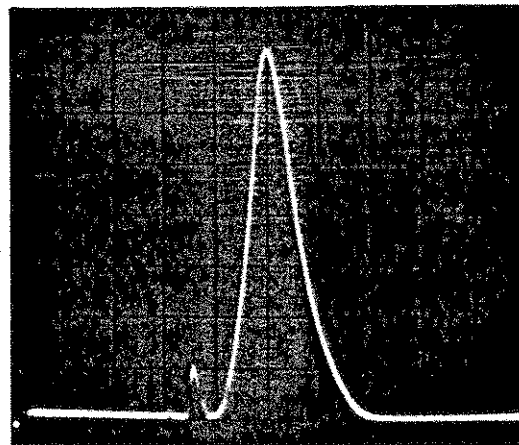

Figure 5-6. RF Level Checks Typical Waveform

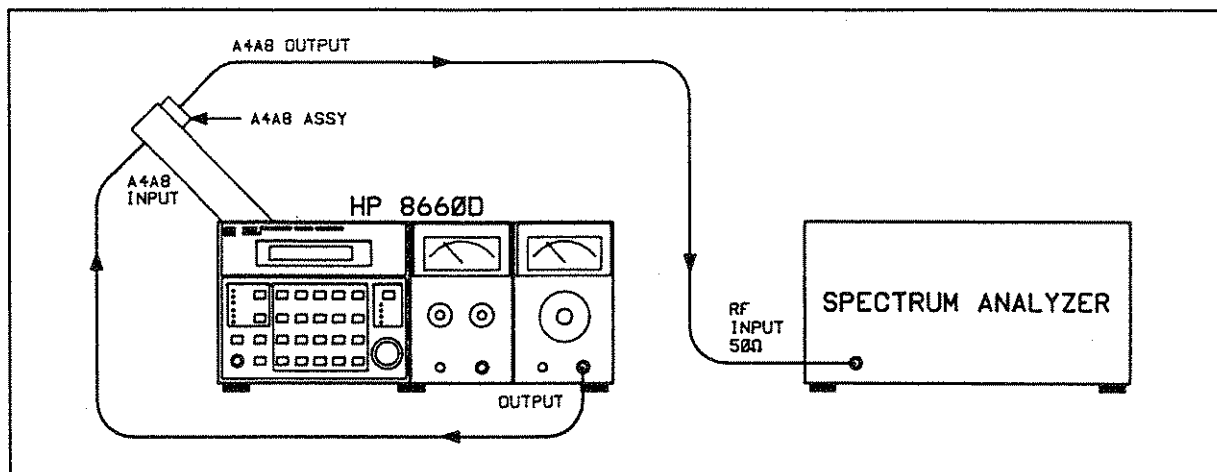

Figure 5-7. 100 MHz Band-pass Filter Adjustment Test Setup

- j. Connect the equipment as shown in Figure 5-7. If necessary, readjust the analyzer controls to center the 100 MHz signal on the display.
 - k. With a non-conducting alignment tool, adjust A4A8C1 and C2 for peak output at 100 MHz.
 - l. Set the spectrum analyzer's vertical sensitivity to 2 dB per division or linear.
 - m. Set the Synthesized Signal Generator sweep width to 50 MHz.
 - n. Verify that the flatness is 3 dB for a bandwidth of > 4 MHz.
 - o. Check that the insertion loss is <1 dB. Bypass the 100 MHz Band-pass Filter and measure the output directly from the signal source. Compare the direct signal with the signal level through the filter. To achieve the 1 dB maximum insertion loss, flatness may be compromised slightly.
 - p. Reconnect W6 to the A4A8 Assembly. Monitor the 100 MHz output level of the of the A4A8 Assembly with the RF voltmeter (into 50Ω).
 - q. Adjust A4C41 for the maximum output level. Verify that the level is between +11 and +13 dBm.
 - r. If the level is incorrect, change A4R29 to a lower value (42.2Ω minimum) and peak the output level. Continue until one output level is 12 ± 1 dBm.
 - s. Reconnect A23W9 to the output of the A4A8 Assembly. Unlock A4 and return it to the original position. Lock A4 into place.
3. 500 MHz Output Adjustment
- a. Connect the Spectrum Analyzer RF INPUT to the 500 MHz output connector on the A4A4 assembly and tune the analyzer to 500 MHz. Set the analyzer scan width to 50 MHz per division and other analyzer controls for a clear display (see Figure 5-6).
 - b. Adjust A4A4C17, A4A4C23 and A4A4C31 for a peak amplitude of the 500 MHz signal. The 500 MHz signal amplitude should be > +3 dBm. The 400 MHz signal observed at the 500 MHz output is typically < -10 dBm. The 600 MHz signal observed at the 500 MHz output is typically < -20 dBm. Disconnect the analyzer.

500 MHz _____dBm

400 MHz _____dBr

600 MHz _____dBm

4. 20 MHz Output Check

- a. Connect the Spectrum Analyzer RF INPUT to the 20 MHz output on the A4A4 assembly and tune the analyzer to 20 MHz. The 20 MHz signal should be > -6 dBm and < -2 dBm. Disconnect the analyzer.

20 MHz _____ dBm

5. Reference Section Outputs Not Previously Checked

- a. Check the outputs listed in Table 5-8 for the levels shown (see Figure 5-8).

Table 5-8. Reference Section Output Levels

Test Point	Frequency	Specified Level	Actual
A4J6	10 MHz	>1 Vp-p	_____
A4J1	2 MHz	>2.2 Vp-p	_____
A4J3	400 kHz	$2.2 < Vp-p < 5.0$	_____
A4J2	100 kHz	$2.2 < Vp-p < 5.0$	_____
A4J4	100 kHz	$2.2 < Vp-p < 5.0$	_____

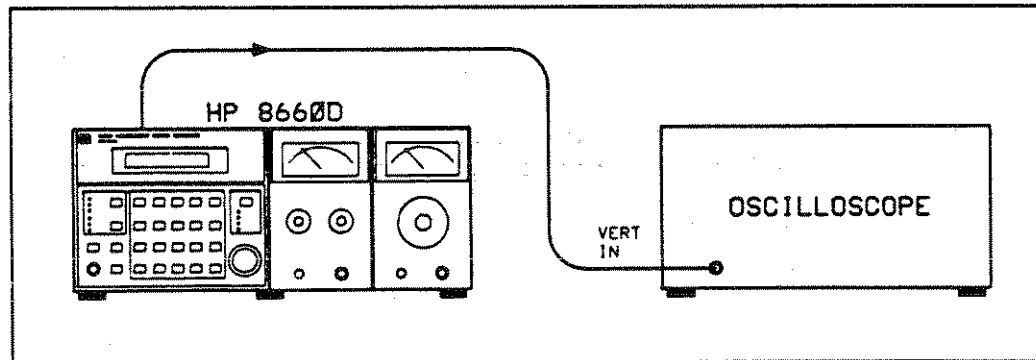

Figure 5-8. Oscilloscope Level Checks Test Setup

Adjustment 4

10 MHZ BANDPASS FILTER ADJUSTMENT (AFTER REPAIR)

NOTE

It is necessary to remove this assembly from the mainframe in order to perform the adjustments. Therefore, this adjustment is to be performed ONLY if the Reference Assembly is repaired.

Description

The 700 Hz sidebands are set at least 20 dB down from the 10 MHz reference oscillator signal.

Test Equipment

Synthesizer.....HP 8660 or 3325A
 RF Voltmeter.....HP 3400A
 50-ohm Feedthrough Termination.....HP 10100C

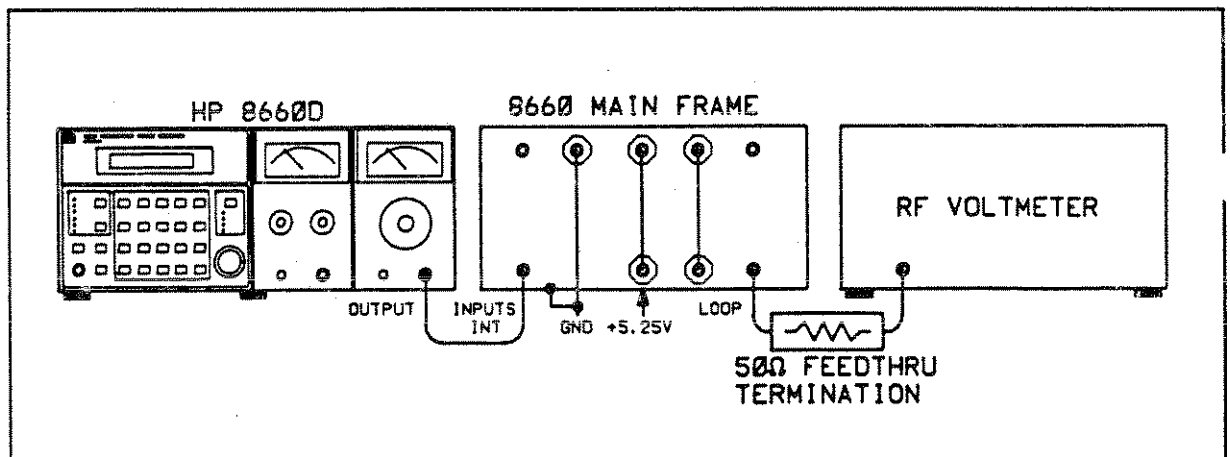

Figure 5-9. A22A1 Adjustment Test Setup (After Repair)

Procedure

1. Connect equipment as shown in Figure 5-9. The +5.25 Vdc source must be connected to the junction of the inductor and feedthrough capacitor. The ground return must be connected to the chassis and the feedthrough capacitor.
2. Release and rotate the A4 assembly up and out of the chassis. Locate A21 output cable J1 (white) and disconnect from reference oscillator A21. Connect external synthesizer to cable. Set Reference Synthesizer to 10.000000 MHz, +13 dBm.

3. Set the unit under test reference switch to INTERNAL.
4. Adjust A22A1C3 for maximum RF Voltmeter reading (use a non-metallic adjustment tool).
5. Adjust A22A1R2 for an RF Voltmeter reading of 270 mVrms.
6. Set the Reference Synthesizer to 10.000700 MHz, record RF Voltmeter reading in dBm.
7. Set the Reference Synthesizer to 0.999300 MHz; record RF Voltmeter reading in dBm.
8. Establish the higher of the power levels in steps 6 and 7 as a reference. Reset the Reference Synthesizer to 10.000000 MHz. Adjust A22A1R6 for a voltmeter reading 20 dBm above the reference.

Example: Reference level	-18 dBm
	<u>+20 dBm</u>
	+ 2 dBm

9. Reinstall the A22 Assembly.
10. Perform Adjustment 5 (10 MHz Bandpass Filter Adjustment).

Adjustment 5

10 MHz BANDPASS FILTER ADJUSTMENT

Description

The A22A1 sub-assembly is adjusted to the internal 10 MHz reference frequency. The assembly level is adjusted for 270 mV into 50 ohms.

Test Equipment

RF Voltmeter..... HP 3400A

50 ohm Feedthrough Termination..... HP 10100C

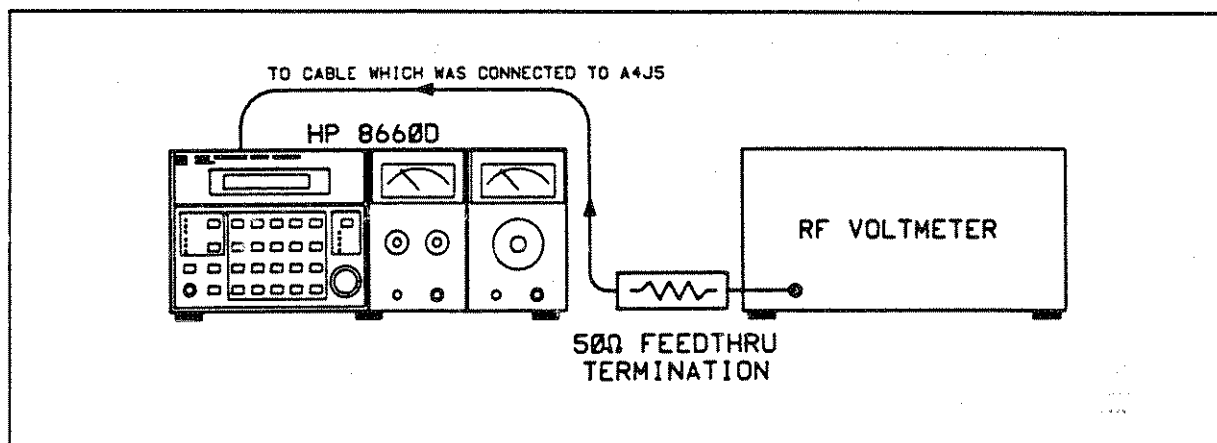

Figure 5-10. A22A1 Adjustment Test Setup

NOTE

Adjustment of the Reference Section (Adjustment 3) is recommended before performing this procedure

Procedure

1. Set up test equipment as shown in Figure 5-10.
2. Remove HP 8660D left side cover and top cover. Turn power ON and allow HP 8660D to operate for 2 hours to ensure reference stability. Set INT/EXT reference switch to INT.
3. Remove 10 MHz Reference input cable from A4J5. Connect the cable to the RF Voltmeter as shown in Figure 5-10.
4. Adjust A22A1C3 (using a non-metallic tool) accessible through hole in A22 assembly for maximum reading on the RF Voltmeter.
5. Adjust A22A1R2 (accessible through a hole in the A22 assembly) for an RF Voltmeter reading of 270 mVrms.
6. Reconnect the Reference Input cable to A4J5.

Adjustment 6

HIGH FREQUENCY SECTION

- Service Sheets 4, 5 and 6.

Description

The High Frequency Section contains a voltage controlled oscillator which provides eleven discrete output frequencies from 350 to 450 MHz in 10 MHz steps. The output of the voltage controlled oscillator is phase locked to a 10 MHz reference derived from the master oscillator in the reference section. The output from the HF section is used in the RF Section plug-in or in the internal frequency extension plug-in module. These checks verify proper operation of the High Frequency Section circuits.

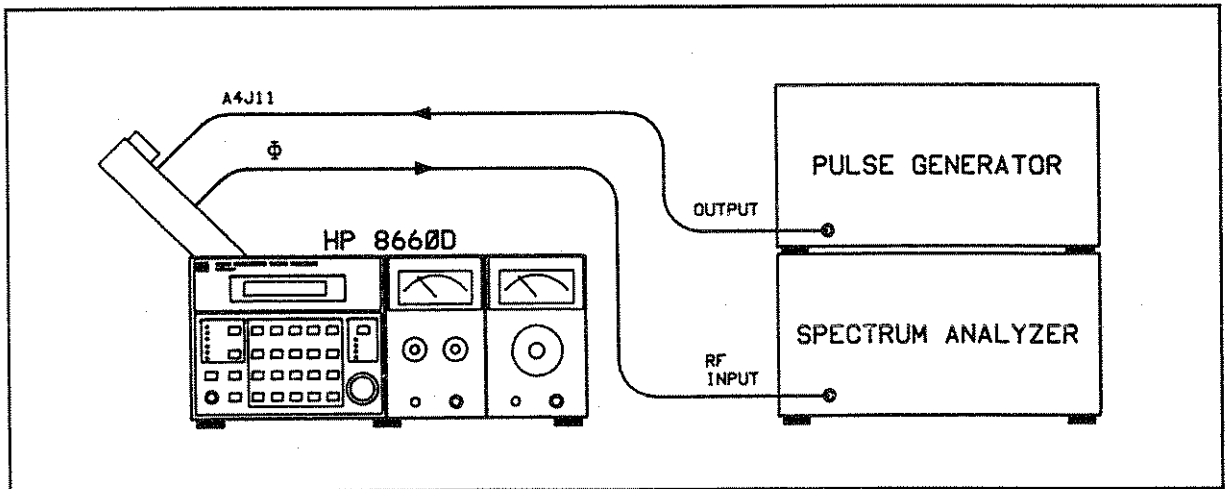

Figure 5-11. Phase Detector Response Adjustment Test Setup

Test Equipment

Frequency Counter	HP 5385A
Digital Voltmeter	HP 3478A
Pulse Generator	HP 8011A
Spectrum Analyzer	HP 8590A
Oscilloscope (with 10:1 divider probes)	HP 54200A
Signal Generator/Test Oscillator	HP 3325A

Procedure

1. Set up test equipment as shown in Figure 5-11.
 - a. Disconnect the coaxial cable from VCO INPUT A4J11. Connect the PULSE OUTPUT of the pulse generator to A4J11. Set the pulse generator for 100 kHz pulse rate, 0.035 μ sec pulse width, 0.5 volt amplitude and + polarity.

- b. Remove the cover of the A4A6 assembly. Connect the spectrum analyzer RF INPUT to the test point marked "Φ" on the A4A6 assembly. This test point should have a white wire and a resistor soldered to it. Set the analyzer controls as follows:

Center Frequency 5 MHz
 Scan Width Per Division 1 MHz
 Scan Time Per Division 1 ms
 Gain and Attenuation as required

- c. Adjust efficiency control A4A7R18 for a flat response to approximately 5 MHz with very slight peaking ($1 \text{ dB} \pm 1 \text{ dB}$). See the waveform in Figure 5-12 for typical response.
- d. Disconnect the pulse generator and the spectrum analyzer.

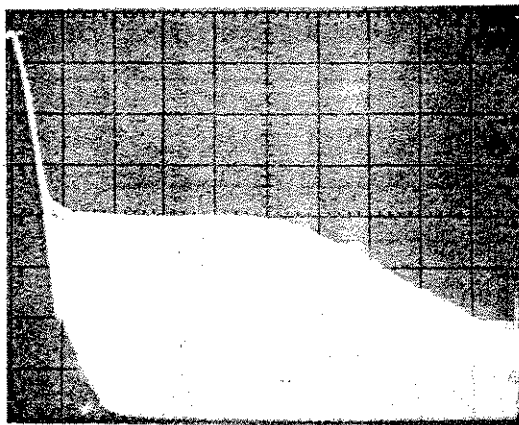

Figure 5-12. Phase Detector Response Waveform

3. Balance Adjustment.
- Connect the digital voltmeter to "phase error" TP.
 - Adjust the BALANCE control (A4A7R22) for a digital voltmeter reading of $0 \text{ volts} \pm 0.05 \text{ volt}$. Disconnect the digital voltmeter.
4. Voltage Controlled Oscillator Adjustment (see Figure 5-13).
- Remove the A4A6 cover. With the output cable of the A4A5 assembly disconnected from the VCO OUTPUT (A4J10), connect the digital voltmeter to the A4A6 Frequency Control output (white/black/violet lead).
 - Adjust the A4A6 "0" CONTROL (A6A6R13) for a digital voltmeter reading of -34 Vdc (voltage should be adjustable from about -33 to -35 Vdc).
 - Connect the frequency counter to the A4A5 voltage controlled oscillator output, A4J12. Replace the A4A6 assembly cover.
 - The counter should display $450 \text{ MHz} \pm 1 \text{ MHz}$. If the correct reading is obtained proceed to step f. If the frequency reading is not correct, proceed to step e.
 - Adjust A4A5C3 for a $450 \text{ MHz} \pm 1 \text{ MHz}$ reading.
 - Disconnect the frequency counter and reconnect the voltage controlled oscillator output to the phase detector.

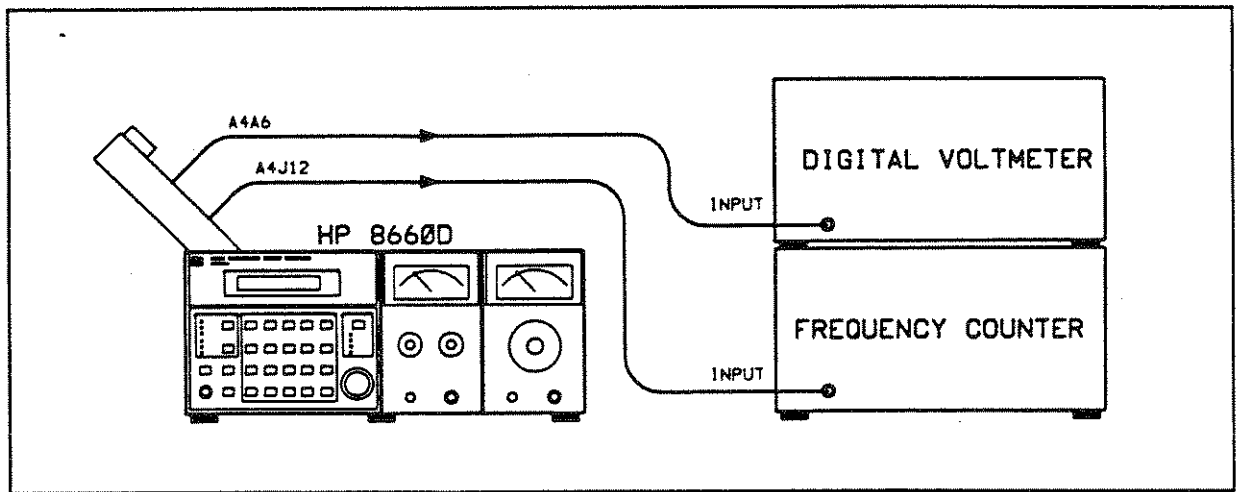

Figure 5-13. Voltage Controlled Oscillator Adjustments Test Setup

- g. Connect the digital voltmeter to the "phase error" test point. Connect the frequency counter to A4J12 (350-450 MHz OUTPUT, white-yellow cable).
- h. Set the center frequencies as shown in Table 5-9 and set the digital-to-analog controls on the A4A6 assembly for 0 ± 0.1 volt for each frequency listed. Note that the counter displays the output frequency listed for each center frequency setting.

NOTE

When the 86602 or 86603 is installed in the mainframe the 350 MHz output of the High Frequency Section is not used. When this situation exists, the adjustment procedure for A4A6R15 "10" is not valid and the following procedure should be substituted:

1. Ground the collector of A4A6Q1.
2. Adjust A4A6R15 "10" for 350 MHz.
3. Remove the ground from the collector of A4A6Q1.

Table 5-9. Pretune Adjustments

Center Frequency	Adjust Control	Counter Readout
0 MHz	A4A6R13"0"	450.000000 MHz
10 MHz	A4A6R60"1"	440.000000 MHz
20 MHz	A4A6R56"2"	430.000000 MHz
30 MHz	A4A6R52"3"	420.000000 MHz
40 MHz	A4A6R48"4"	410.000000 MHz
50 MHz	A4A6R44"5"	400.000000 MHz
60 MHz	A4A6R40"6"	390.000000 MHz
70 MHz	A4A6R35"7"	380.000000 MHz
80 MHz	A4A6R28"8"	370.000000 MHz
90 MHz	A4A6R22"9"	360.000000 MHz
100 MHz	A4A6R15"10"	350.000000 MHz

NOTE

The adjustments shown in Table 5-9 should be made with the counter time base connected to the synthesizer REFERENCE OUTPUT.

- i. If any of the controls listed in Table 5-9 cannot be adjusted to 0 volts, adjust A4A6R20 "profile" to obtain additional range. Repeat all pretune adjustments until satisfactory results are obtained. Disconnect the digital voltmeter and the frequency counter.
5. Loop Gain Adjustment (see Figure 5-14).
 - a. With the center frequency set to 0 MHz connect the Spectrum Analyzer RF INPUT to A4J12 (350-450 MHz OUTPUT) and set the analyzer controls as follows:

Center Frequency	450 MHz
Bandwidth	30 kHz
Scan Width Per Division	0.5 MHz
Scan Time Per Division	5 ms
 - b. Disconnect the reference input to A4J13 (10 MHz output from A4A4) and reconnect it together with the RF output of the Signal Generator/Sweeper.
 - c. Set the Signal Generator/Sweeper to 11.5 MHz CW at -35 dBm and symmetrical sweep width to 3 MHz. The analyzer display should be approximately as shown in the typical waveform shown in Figure 5-15. Adjust the A4A6 GAIN control (A4A6R2) for the response shown.
 - d. Disconnect the Analyzer and the Generator/Sweeper. Reconnect the reference signal to A4J13.

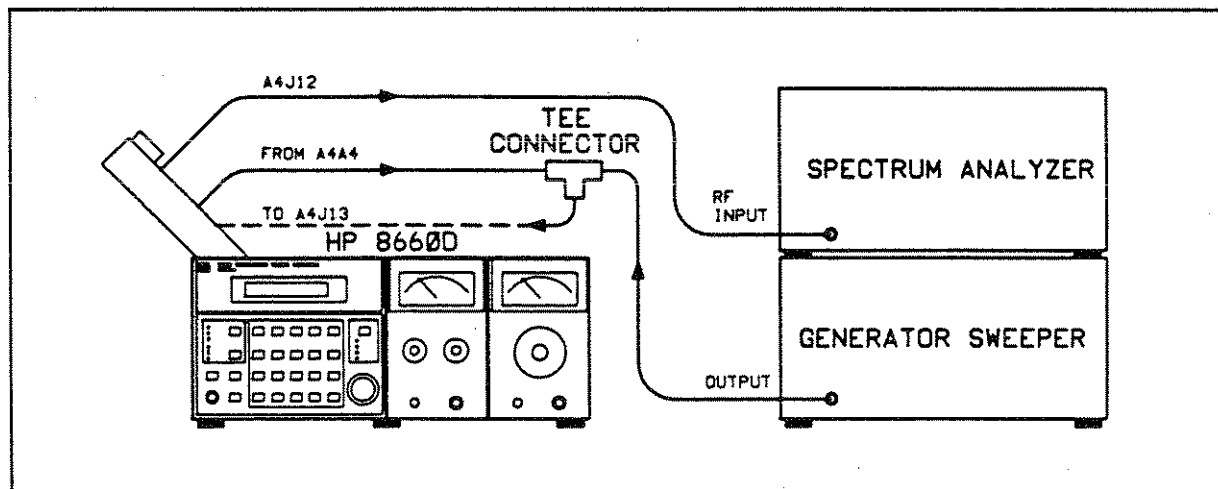

Figure 5-14. Loop Gain Adjustment Test Setup

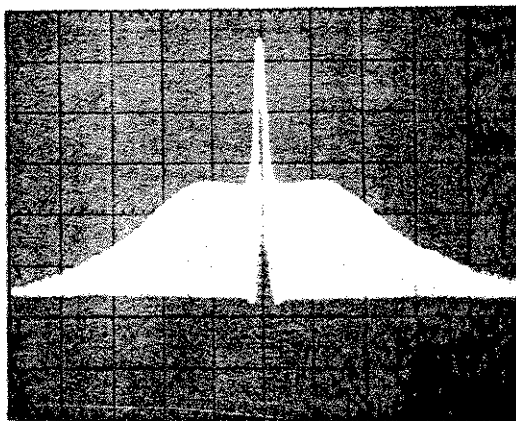

Figure 5-15. Loop Gain Adjustment Waveform

6. 10 MHz Trap Adjustment (see Figure 5-16).

NOTE

This adjustment is necessary only if the A4A6 10 MHz trap has been repaired.

- a. Disconnect the coaxial cable from A4J10 (350/450 MHz to Φ detector).
- b. Disconnect the 10 MHz reference signal from A4J13 and reconnect it using a TEE connector. Connect the 10 MHz reference signal from the other TEE port to the Φ input of the A4A6 assembly (white wire from the A4A7 assembly).
- c. Connect the Spectrum Analyzer RF INPUT to the A4A6 Frequency control output (white-black-violet wire). Set the analyzer controls as follows:

Center Frequency	10 MHz
Bandwidth	30 kHz
Scan Width Per Division	200 kHz
Video Filter	OFF
Input Attenuation	0 dB
Scan Time Per Division	1 msec
Ref Level	-30 dBm

- d. Adjust A4A6C5 trap for minimum 10 MHz amplitude.
- e. Reconnect Φ input to A4A6.
- f. Replace all High Frequency Section Covers.

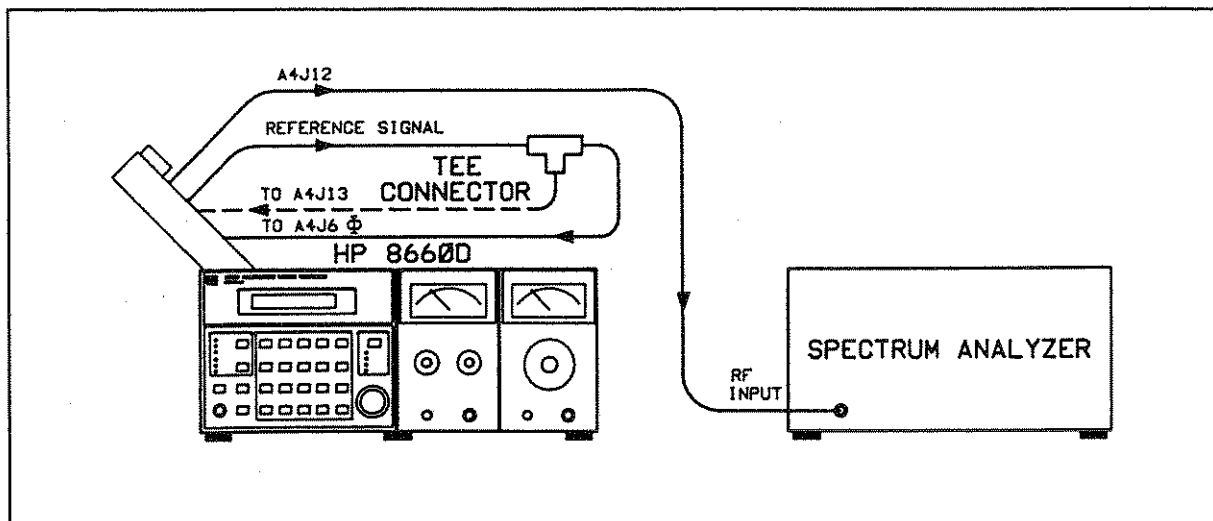

Figure 5-16. 10 MHz Trap Adjustment Test Setup

7. Output Frequency and Amplitude Check (see Figure 5-17).

- a. Set the HP 8660D CF to 6 MHz.
- b. Connect the Spectrum Analyzer RF INPUT to A4J12. Set the analyzer controls as required to view the 450 MHz signal. The output should be +13 dBm to +15 dBm. To increase or decrease output, change resistors A4A5R38, R40, R42. See Table 5-2 for suggested sets of values.

- c. Switch digits 9 and 8 from 00 through 10. The frequency should decrease in 10 MHz ste, (amplitude at +13 dBm minimum).

440 MHz	_____ dBm	430 MHz	_____ dBm	420	_____ dBm
410 MHz	_____ dBm	400 MHz	_____ dBm	390	_____ dBm
380 MHz	_____ dBm	370 MHz	_____ dBm	360	_____ dBm
350 MHz	_____ dBm				

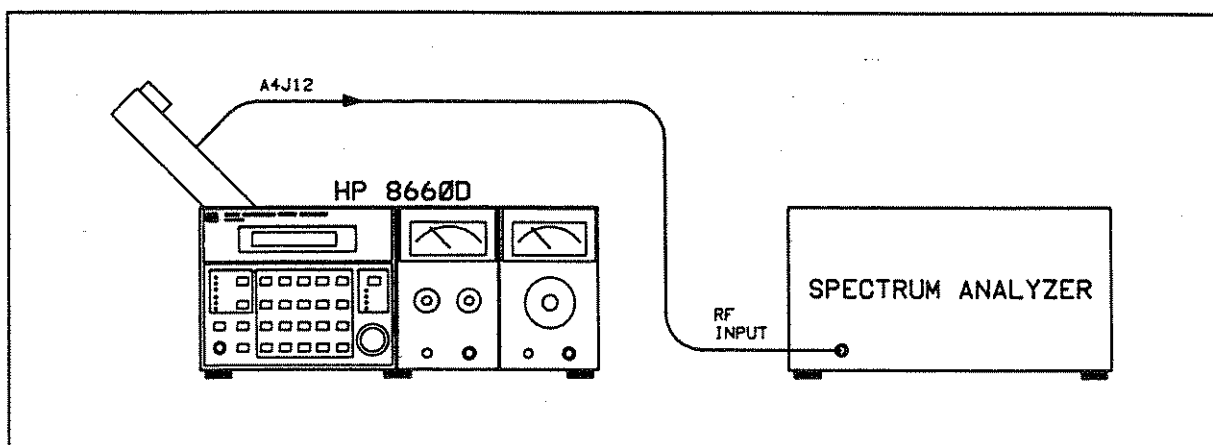

Figure 5-17. Output Frequency and Amplitude Check Test Setup

Adjustment 7

N1 PHASE LOCK LOOP

- Service Sheets 7 and 8

Description

The N1 phase lock loop produces digitally controlled RF signals from 19.8 to 29.7 MHz in 100 kHz steps. The output frequency is controlled by changing the 1 MHz and 100 kHz digits of the front panel display. The following procedure adjusts the pretuning circuitry of the loop.

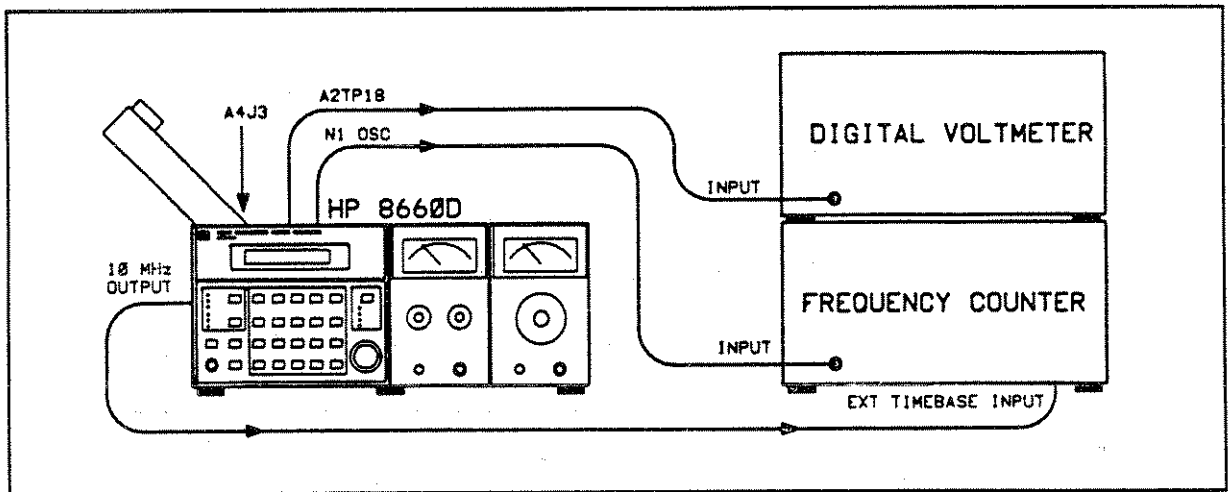

Figure 5-18. N1 Loop Test Setup

Test Equipment

Digital Voltmeter	HP 3478A
Frequency Counter	HP 5385A

Procedure

1. Set up test equipment as shown in Figure 5-18.
2. Enter 0 MHz center frequency and ground A2 Motherboard test point A2TP16 with one of the jumper plugs provided. Connect the digital voltmeter to A2TP18.
3. Adjust A17R31 (or A17R28) for a voltmeter reading of $-30 \text{ Vdc} \pm 0.1 \text{ Vdc}$, and disconnect the digital voltmeter.
4. Connect the frequency counter to the N1 oscillator output on the A2 mother board and adjust A17C17 for a counter reading of $29.70 \text{ MHz} \pm 0.02 \text{ MHz}$.
5. Set the HP 8660D center frequency to 9.5 MHz. Adjust A17R31 for a counter reading of $20.2 \text{ MHz} \pm 0.02 \text{ MHz}$. (Hint: Set the Step Freq increment to 9 MHz).
6. Set the HP 8660D center frequency to 0.5 MHz. Adjust A17R28 for a counter reading of $29.2 \text{ MHz} \pm 0.02 \text{ MHz}$.
7. The adjustments in steps 5 and 6 are interactive. Repeat these adjustments until both counter readings are within tolerance.

8. Remove the ground jumper from A2TP16.
9. Disconnect the 400 kHz reference signal by disconnecting the cable from A4J3 and connect the digital voltmeter to A2TP17. Adjust A16R38 for a digital voltmeter readout of $0V \pm 10$ mV. Reconnect the 400 kHz reference signal.
10. Set the HP 8660D center frequency to 9.5 MHz. The frequency counter reading should be 20.200000 MHz. Adjust A17R31 for a DVM reading of $0V \pm 100$ mVdc at TP17.
11. Set the HP 8660D center frequency to 0.5 MHz. The frequency counter reading should be 29.200000 MHz. Adjust A17R28 for a DVM reading of $0V \pm 100$ mVdc at TP17.
12. The adjustments in steps 10 and 11 are interactive. Repeat these steps until the DVM reading is within tolerance at both frequency settings.
13. Enter the center frequencies shown in Table 5-10. The counter readings should be as shown in the table. (Hint: Set the Step Freq increment to 1.1 MHz).

Table 5-10. N1 Loop Output Frequency Checks

Center Frequency	Counter Readout
0	29.700000 MHz
1.1 MHz	28.600000 MHz
2.2 MHz	27.500000 MHz
3.3 MHz	26.400000 MHz
4.4 MHz	25.300000 MHz
5.5 MHz	24.200000 MHz
6.6 MHz	23.100000 MHz
7.7 MHz	22.000000 MHz
8.8 MHz	20.900000 MHz
9.9 MHz	19.800000 MHz

NOTE

The adjustments shown in Table 5-10 should be made with the counter time base connected to the synthesizer REFERENCE OUTPUT.

Adjustment 8

N2 PHASE LOCK LOOP

- Service Sheets 9 and 10

Description

The N2 phase lock loop produces digitally controlled RF signals from 19.80 to 29.79 MHz in 10 kHz increments. The output frequency is controlled by changing the 10 kHz, 1 kHz, and 100 Hz digits of the front panel display. The following procedure adjusts the pretuning circuitry of the loop.

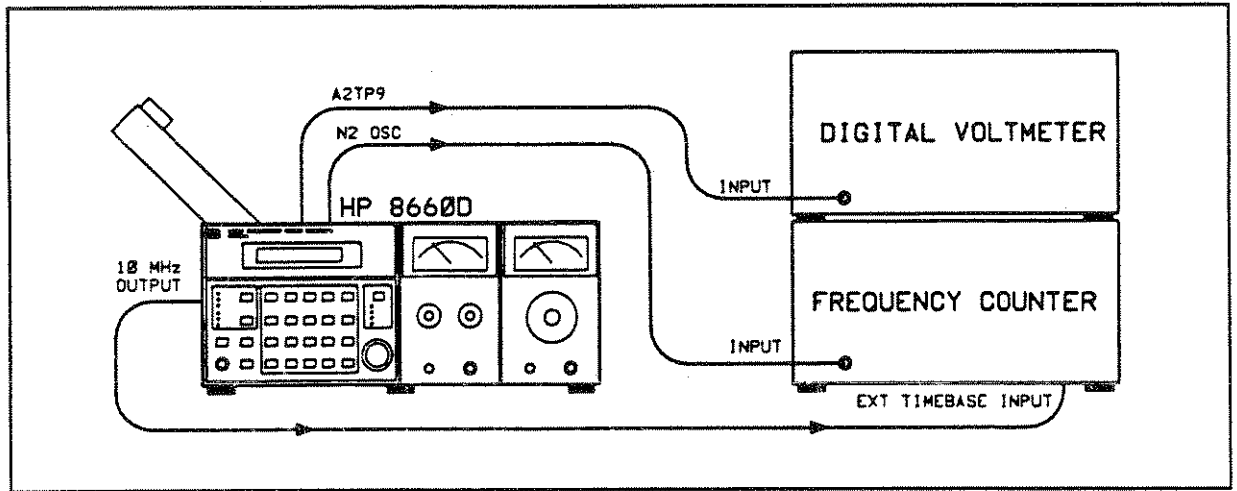

Figure 5-19. N2 Loop Test Setup

Test Equipment

- | | |
|-------------------------|----------|
| Digital Voltmeter | HP 3478A |
| Frequency Counter | HP 5385A |

Procedure

1. Set up test equipment as shown in Figure 5-19.
2. Set the center frequency to 0 MHz and ground A2TP12 on the A2 Motherboard with one of the jumper plugs provided.
3. Connect the digital voltmeter to A2TP9 and adjust A13R37 (or A13R39) to $-30V \pm 0.1$ Vdc. Disconnect the digital voltmeter.
4. Connect the frequency counter to the N2 oscillator output at XA13-14. Adjust A13C19 for a counter reading as close as possible to $29.79 \text{ MHz} \pm 0.02 \text{ MHz}$.
5. Set the HP 8660D center frequency to 95.5 kHz. Adjust A13R37 for a counter reading of $20.24 \text{ MHz} \pm 0.020 \text{ MHz}$. (Hint: Set the Step Freq increment to 90 kHz).
6. Set the HP 8660D center frequency to 5.5 kHz. Adjust A13R39 for a frequency counter reading of $29.24 \text{ MHz} \pm 0.020 \text{ MHz}$.
7. The adjustments in steps 5 and 6 are interactive. Repeat these steps until both counter readings are within tolerance.

8. Remove the ground from A2TP12.
9. Connect the voltmeter to A2 Motherboard TP10.
10. Set the HP 8660D center frequency to 95.5 kHz. The frequency counter reading should be 20.240000 MHz. Adjust A13R37 for a DVM reading of $0V \pm 100$ mVdc.
11. Set the HP 8660D center frequency to 5.5 kHz. The frequency counter reading should be 29.240000 MHz. Adjust A13R39 for a DVM reading of $0V \pm 100$ mVdc.
11. The adjustments in steps 10 and 11 are interactive. Repeat these steps until the DVM reading is within tolerance at both frequency settings.
12. Set center frequency as shown in Table 5-11. The counter readings should be as shown in the table. (Hint: Set the Step Freq increment to 11.1 kHz).

Table 5-11. N2 Loop Output Frequency Checks

Center Frequency	Counter Readout N2
0	29.790000 MHz
11.1 kHz	28.680000 MHz
22.2 kHz	27.570000 MHz
33.3 kHz	26.460000 MHz
44.4 kHz	25.350000 MHz
55.5 kHz	24.240000 MHz
66.6 kHz	23.130000 MHz
77.7 kHz	22.020000 MHz
88.8 kHz	20.910000 MHz
99.9 kHz	19.800000 MHz

Adjustment 9

N3 PHASE LOCK LOOP

- Service Sheets 11 and 12

Description

The N3 phase lock loop produces digitally controlled RF signals from 2.001 to 2.100 MHz in 1 kHz increments. The output frequency is controlled by changing the 1 Hz and 10 Hz digits of the display. The following procedure adjusts the pretuning circuitry of the loop.

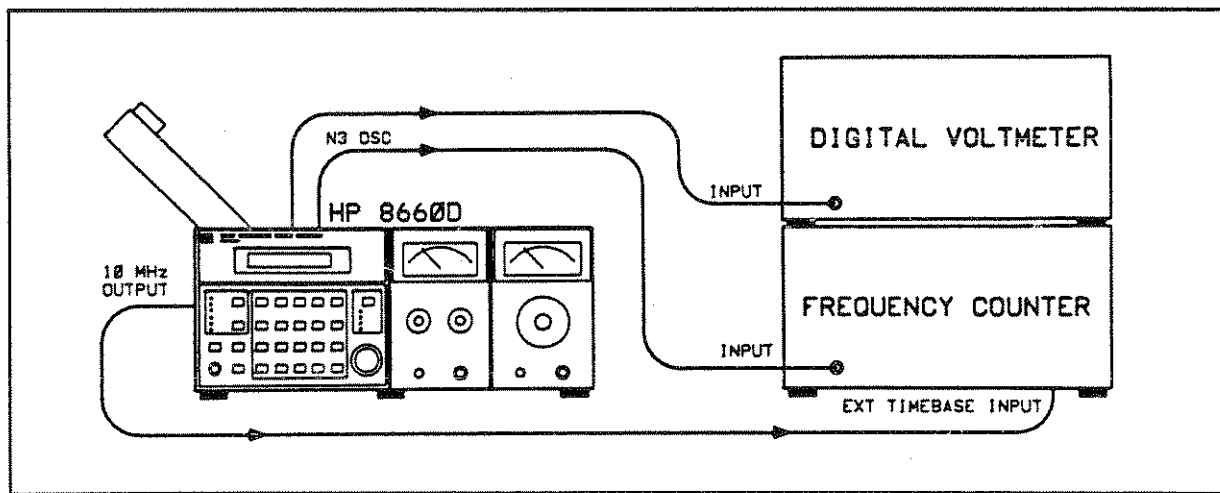

Figure 5-20. N3 Loop Test Setup

Test Equipment

Digital Voltmeter	HP 3478A
Frequency Counter	HP 5385A

NOTE

The A2 Motherboard test points used in this procedure are covered up by the HP 8660D DCU. To access these test points, remove the 4 screws holding the DCU to the chassis and slide it forward. Refer to the Remote Selection procedure in Section 2 if needed.

Procedure

1. Set up test equipment as shown in Figure 5-20.
2. Set the HP 8660D center frequency to 95 Hz. Ground A2TP4 on the A2 Motherboard with one of the jumpers provided.
3. Connect the frequency counter to the A2 Motherboard test point labeled N3 OSC, which is adjacent to XA8-1 pin 7. (The other test point labeled N3 OSC is the VCO output after the frequency is divided by 10). Adjust A8R26 for a counter reading of 20.05 ± 0.02 MHz.
4. Set the HP 8660D center frequency to 5 Hz. Adjust A8R24 for a counter reading of 20.95 ± 0.02 MHz.

5. The adjustments in steps 3 and 4 are interactive. Repeat these adjustments until both counter readings are within tolerance.
6. Connect the voltmeter to A2 Motherboard TP3.
7. Remove the ground from A2 TP4.
8. Set the HP 8660D center frequency to 95 Hz. The counter reading should be 20.050000 MHz. Adjust A8R26 for a DVM reading of $0V \pm 100$ mVdc.
9. Set the HP 8660D center frequency to 5 Hz. The counter reading should be 20.950000 MHz. Adjust A8R24 for a DVM reading of $0V \pm 100$ mVdc.
10. The adjustments in steps 8 and 9 are interactive. Repeat these steps until the DVM reading is within tolerance at both frequency settings.
11. Set center frequencies as shown in Table 5-12. The counter readings should be as shown in the table.

Table 5-12. N3 Oscillator Output Frequency Checks

Center Frequency	Counter Readout
0	21.000000 MHz
11 Hz	20.890000 MHz
22 Hz	20.780000 MHz
33 Hz	20.670000 MHz
44 Hz	20.560000 MHz
55 Hz	20.450000 MHz
66 Hz	20.340000 MHz
77 Hz	20.230000 MHz
88 Hz	20.120000 MHz
99 Hz	20.010000 MHz

Adjustment 10

SUMMING LOOP 2 (SL2)

• Service Sheets 13 and 14

Description

SL2 is a phase lock loop that provides a digitally controlled RF output to Summing Loop 1. This output, which is from 20.0001 to 30.000 MHz in 100 Hz steps, is controlled by changing the frequency of the N2 and N3 phase locked loops. The following procedure adjusts the pretuning circuitry of the loop.

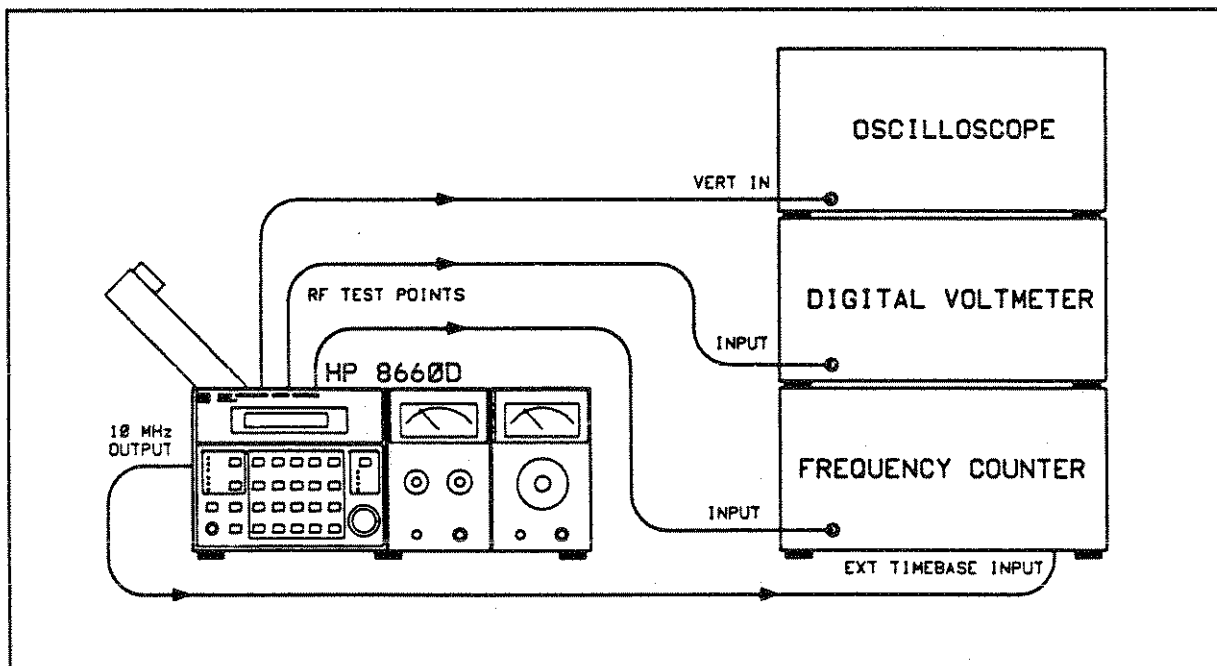

Figure 5-21. SL2 Test Setup

Test Equipment

Digital Voltmeter	HP 3478A
Frequency Counter	HP 5385A
Oscilloscope (10:1 divider probes)	HP 54200A

Procedure

1. Set up the test equipment as shown in Figure 5-21.
2. Set the HP 8660D center frequency to 0 MHz. Ground A2TP8 on the A2 Motherboard.

NOTE

The A2 Motherboard test points used in this procedure are covered by the interface boards, A3A1 and A3A2. The HP 8660D will not function with the interface boards removed. The best way to access these test points is to use a short piece of wire (#14 AWG) with one end filed to a point. The pointed end of the wire can be forced into the test points located between the interface boards. Then the oscilloscope or DVM probe can be connected to the other end of the wire. Likewise, instead of using the plug-in jumper to short TP 8 to ground, insert the piece of wire into TP8 and connect a jumper from the wire to ground. The HP 8660D DCU must be moved forward to gain access to TP5. See Remote Selection in Section 2 for this procedure.

3. Connect the voltmeter to A2 Motherboard TP5. Adjust A11R19 for a DVM reading of $-30V \pm 0.1$ Vdc. Remove the voltmeter from TP5.
4. Connect the counter to the A2 Motherboard TP6 (SL2 OSC). Adjust A11C17 for a counter reading of $30V \pm 0.02$ MHz.
5. Set the HP 8660D center frequency to 94.5 kHz. Adjust A11R19 for a counter reading of 20.55 ± 0.02 MHz.
6. Set the HP 8660D center frequency to 4.5 kHz. Adjust A11R15 for a counter reading of 29.55 ± 0.02 MHz.
7. The adjustments in steps 4 and 5 are interactive. Repeat these steps until both counter readings are within tolerance.
8. Remove the ground from the A2 TP8.
9. Set the HP 8660D center frequency to 94.5 kHz. Connect the voltmeter to A2 Motherboard TP7 and adjust A11R19 for a DVM reading of $0V \pm 5$ mVdc.
10. Connect the oscilloscope to A2 Motherboard TP7. Adjust A12R37 for a square wave with 50/50 symmetry. Remove the oscilloscope.
11. Set the HP 8660D center frequency to 4.5 kHz. Adjust A11R15 for a DVM reading of $0V \pm 100$ mVdc at A2TP8.

NOTE

The voltage readings will drift immediately after a frequency change. Wait until the reading stabilizes before making the adjustment.

12. Set the HP 8660D center frequency to 94.5 kHz. Adjust A11R19 for a DVM reading of $0V \pm 100$ mVdc.
13. The adjustments in steps 11 and 12 are interactive. Repeat these steps until both DVM readings are within tolerance.
14. Set the HP 8660D center frequency to the values given in Table 5-13. At each frequency setting adjust the control listed in the table for a DVM reading of $0V \pm 100$ mVdc. The frequency at TP6 SL2 OSC should be as shown in the table.

Table 5-13. SL2 Oscillator Output Frequency Adjustments

Center Frequency	Adjust	Counter Readout
84.5 kHz	A11R39 "8"	21.55 MHz \pm 20 kHz
74.5 kHz	A11R54 "7"	22.55 MHz \pm 20 kHz
64.5 kHz	A11R60 "6"	23.55 MHz \pm 20 kHz
54.5 kHz	A11R67 "5"	24.55 MHz \pm 20 kHz
44.5 kHz	A11R73 "4"	25.55 MHz \pm 20 kHz
34.5 kHz	A11R77 "3"	26.55 MHz \pm 20 kHz
24.5 kHz	A11R83 "2"	27.55 MHz \pm 20 kHz
14.5 kHz	A11R90 "1"	28.55 MHz \pm 20 kHz

Adjustment 11

SUMMING LOOP 1 (SL1)

- Service Sheet 15, 16 and 17.

Description

SL1 is a phase lock loop that provides a digitally controlled RF output to the RF Section plug-in. This output, which is from 20.000001 to 30.000000 MHz in 1 Hz steps is controlled by changing the N1 and SL2 phase locked loops. The following procedure adjusts the pretuning circuitry of the loop.

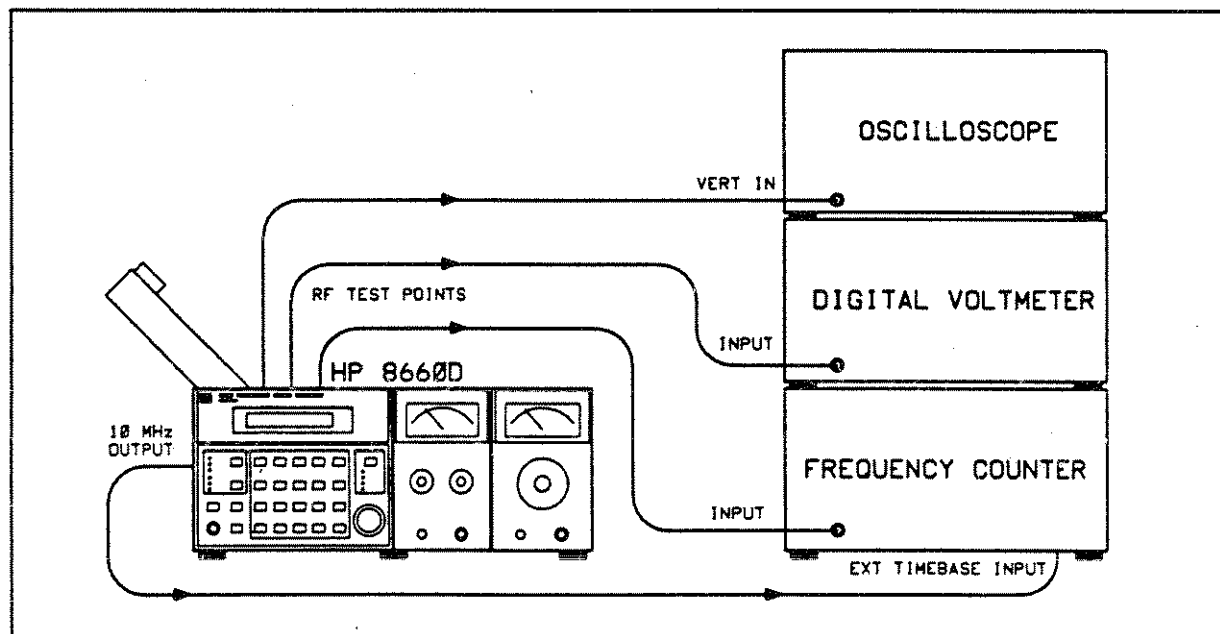

Figure 5-22. SL1 Test Setup

Test Equipment

Digital Voltmeter	HP 3478A
Frequency Counter	HP 5385A
Oscilloscope (10:1 divider probes)	HP 54200A

Procedure

1. Set up test equipment as shown in Figure 5-22.
2. Set the HP 8660D center frequency to 0 Hz. Connect a plug-in jumper on the A2 Motherboard between TP14 and GND.
3. Connect the voltmeter to A2TP21. Adjust A19R9 for $-30V \pm 0.1$ Vdc. Remove the voltmeter cable from TP21.
4. Connect the frequency counter to the A2 Motherboard test point labeled SL1 OSC. Adjust A19C18 for a counter reading of $30 \text{ MHz} \pm 0.02 \text{ MHz}$.
5. Set the center frequency to 9.45 MHz. Adjust A19R9 for a counter reading of $20.55 \text{ MHz} \pm 0.02 \text{ MHz}$.

6. Set the HP 8660D center frequency to 0.45 MHz. Adjust A19R3 for a counter reading of $29.55 \text{ MHz} \pm 0.02 \text{ MHz}$.
7. The adjustments in steps 5 and 6 are interactive. Repeat these steps until both counter readings are within tolerance.
8. Remove the jumper from the A2 Motherboard.
9. Set the HP 8660D center frequency to 9.45 MHz. Connect the voltmeter to A2 Motherboard TP14.
10. Adjust A19R9 for a DVM reading of $0 \text{ mVdc} \pm 5 \text{ mVdc}$.
11. Connect the oscilloscope to A2 Motherboard TP13. Adjust A15R14 for a square wave with 50/50 symmetry. Remove the oscilloscope.
12. Set the HP 8660D center frequency to 0.45 MHz. Adjust A19R3 for a DVM reading of $0 \text{ mVdc} \pm 100 \text{ mVdc}$ at A2 TP14.

NOTE

The voltage reading will drift immediately after a frequency change. Wait until the reading stabilizes before making the adjustment.

13. Set the HP 8660D center frequency to 9.45 MHz. Adjust A19R9 for a DVM reading of $0 \text{ mVdc} \pm 100 \text{ mVdc}$.
14. The adjustments in steps 12 and 13 are interactive. Repeat these steps until both DVM readings are within tolerance.
15. Set the HP 8660D center frequency to the values given in Table 5-14. At each frequency setting adjust the control listed in the table for a DVM reading of $0 \text{ mVdc} \pm 100 \text{ mVdc}$. The frequency counter reading at the test point called SL1 OSC should be as shown in the table.

Table 5-14. SL1 Oscillator Output Frequency Adjustments

Center Frequency	Adjust	Counter Readout
8.45 MHz	A18R35 "8"	$21.550 \text{ MHz} \pm 20 \text{ kHz}$
7.45 MHz	A18R40 "7"	$22.550 \text{ MHz} \pm 20 \text{ kHz}$
6.45 MHz	A18R44 "6"	$23.550 \text{ MHz} \pm 20 \text{ kHz}$
5.45 MHz	A18R51 "5"	$24.550 \text{ MHz} \pm 20 \text{ kHz}$
4.45 MHz	A18R55 "4"	$25.550 \text{ MHz} \pm 20 \text{ kHz}$
3.45 MHz	A18R62 "3"	$26.550 \text{ MHz} \pm 20 \text{ kHz}$
2.45 MHz	A18R67 "2"	$27.550 \text{ MHz} \pm 20 \text{ kHz}$
1.45 MHz	A18R74 "1"	$28.550 \text{ MHz} \pm 20 \text{ kHz}$

Adjustment 12

DCU SWEEP OUTPUT

- Service Sheet 25

Description

The HP 8660D sweep output is used to drive the horizontal sweep of an oscilloscope while the RF output is used to determine the characteristics of a device being tested. This procedure properly adjusts the sweep ramp output.

Test Equipment

Digital Voltmeter HP 3478A

Procedure

1. Remove the bottom cover from the HP 8660D.
2. Connect the DVM to the 0 - 8V output on the front panel. Set the DVM to measure DC volts.
3. Enter 1.0005 MHz center frequency and 1 kHz sweep width.
4. Set Sweep Mode to Manual.
5. Using the tuning knob, set frequencies shown in Table 5-15 and make the indicated adjustments. All adjustments must be ± 1 mVdc.

Table 5-15. Adjustments

Step	Frequency	Adjust
1	1.000799 MHz	Record DVM output reading (typically 6.392V)
2	1.000800 MHz	R29 for an output 8 mV greater than above. Reading is typically 6.4V
3	1.000999 MHz	R11 for an output of 7.992V
4	1.000000 MHz	R28 for an output of 0.000V
		Repeat steps 1 through 4
5	1.001000 MHz	R30 for an output of 8.000V

Table 5-16. Frequency Versus Exact Output Levels

Frequency	Output Level
1.000000 MHz	0.000V
1.000799 MHz	6.392V
1.000800 MHz	6.400V
1.000999 MHz	7.992V
1.001000 MHz	8.000V
Nominal step size 8 mV/Hz	

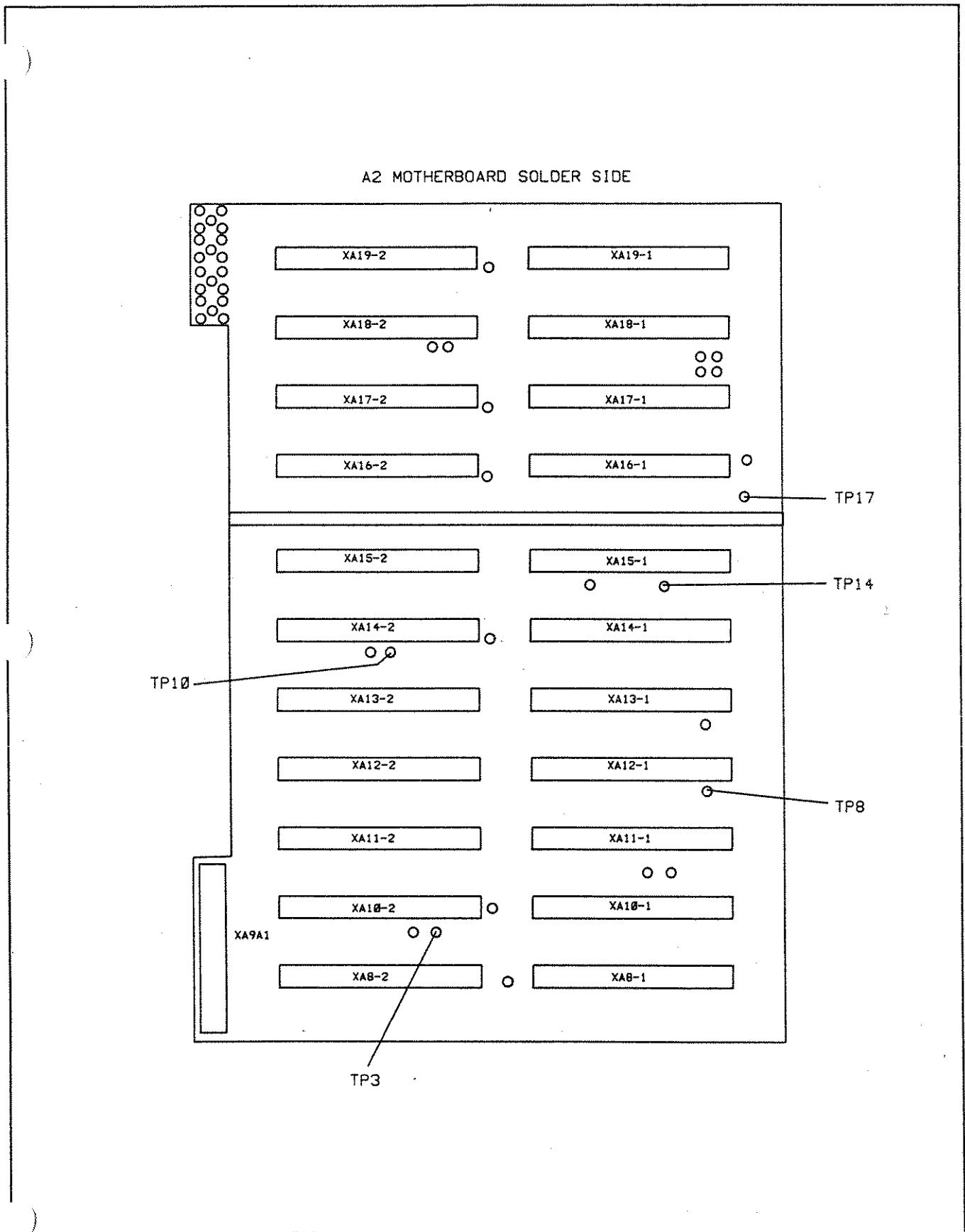

Figure 5-23. A2 Test Point Locator

